

# Product Specification Guide

Technical information, installation requirements and guidance on industry legislation

# Global Interests

Whilst our roots are firmly in the UK, we are a truly international business.



**SE Controls  
Asia Pacific (SECAP)**  
Hong Kong  
(Established 2007)

**SE Controls  
Africa (SECAF)**  
Durban  
(Established 2009)

**SE Controls  
India (SECIN)**  
Chennai  
(Established 2011)

**SE Controls  
Middle East (SECME)**  
United Arab Emirates  
(Established 2012)

# Who We Are & What We Offer

**SE Controls is a leading specialist in the design and delivery of smoke ventilation and environmental ventilation systems using façade automation as an integral part of the building envelope.**

Since 1981 SE Controls has been developing innovative control systems that harness sustainable natural elements to create a safer and healthier indoor environment. This family owned business has grown from a humble start into an international business delivering products and projects across several continents.

Our customers benefit from qualified advice and technical support that is at the leading edge of international regulations and product development. Our products are designed and tested to international standards keeping our customers at the forefront of technology.

## Knowledge and Accreditation

SE Controls works closely with all significant industry bodies and leading roof light and vent manufacturers in testing our products as a combined fully compliant system to the required standards, such as EN 12101-2.



## Profile specific 'Standard details' available on request.

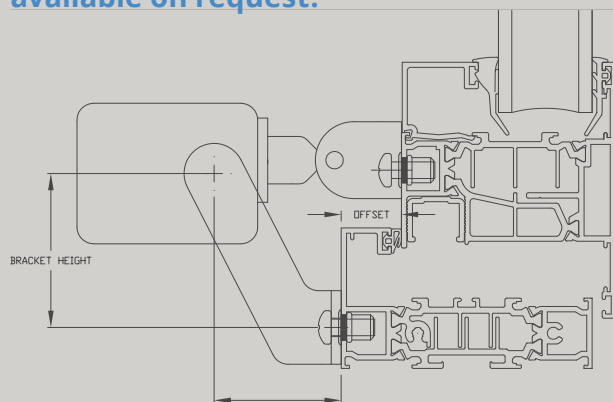

# Partner Support

## In house training



All Partners are upskilled at our dedicated in house training facility to ensure that all their engineers have the correct knowledge base to understand and specify SE Controls' products.

- Controls
- Actuators
- Standards & Legislation
- Product selection
- Installation
- Commissioning

## On site training



All Partners are fully trained on site to ensure professional and accurate installation and commissioning of SE Controls' products.

- On site guidance
- Supported by fully qualified SE Controls' engineers
- Validation of initial installation

## On site appraisals



All Partner's installations will be subject to on going on site appraisals to ensure continued and consistent quality of installation.

- Carried out by experienced SE Controls' engineers
- Additional training and support offered if required
- Feedback from appraisal available on request

## Plug and play solutions



Remote access functionality available to SE Controls Partners using Sceptre Programmer to enable immediate analysis and trouble-shooting of all on site queries.

- Full remote commissioning of site available via WiFi
- Enables direct and immediate support via SE Controls Technical Support Team
- Ideal for long distance installation support (including overseas)

## Help is at hand



With a wealth of industry knowledge gained over many years of both manufacturing and contract installation, SE Controls has the ability to support its Partners in all aspects of design and installation.

- Technical Support Team
- Technical Support Engineers
- SE Controls Knowledge Hub
  - Online customer support system
  - Information library
  - FAQs
  - Out of hours support

## Partner accreditation



All Partners are recognised through the SE Controls Recommended Partner certification scheme.

- Certificate to confirm Recommended Partner status
- Partners are supported through continued training and development
- Partner status reviewed regularly

# Sceptre Programmer

The Sceptre Programmer is SE Controls' custom programming software tool which enables parameters to be set and adjusted to meet the requirements of individual installations.

- Remote access technical support for speedy resolution to on site complications
- Skilled and experienced engineers on hand for one to one support
- Downloadable controls history and data logging functionality (Excel)
- Enables onsite customisation of controller settings
- Service and diagnostic ability
- Ability to record and print event logs

## Screenshot Of Live Monitor Page

The screenshot displays the Sceptre Programmer software interface. On the left, there is a red and white 'SE CONTROLS' logo and a network status indicator showing '052' and '053' with green and red status lights. The main area features a table with columns for ID, Parameter Name, Def., Value, Min., and Max. The table lists various parameters such as 'Positional feedback mode', 'Positional error count', and 'Natural ventilation full stroke'. To the right of the table, there are 'Get Time' and 'Set Time' buttons. Further right, a 'BMS-10' control panel is visible, showing three buttons labeled 'PL10', 'PL11', and 'PL12', each with a '1' or '0' indicator. Below these buttons, there are labels for 'ANALOG - Analogue Out' and 'POS - Position', both marked as 'Not Enabled by 271'. A 'More Info' button is located at the bottom of the control panel.

ID	Parameter Name	Def.	Value	Min.	Max.
2	011 - Positional feedback mode	0	0	0	1000
4	010 - Positional error count	0	0	0	10000
6	007 - Positional compressor valve	70	70	0	100
8	015 - Shoulder pulley pressure	7000	7000	1000	10000
10	014 - Guard trip mode	0	0	0	1000
12	021 - Actuator 1 output maximum c...	0	0	0	10000
14	022 - Actuator 1 output maximum c...	8000	8000	0	10000
16	023 - Actuator 1 output maximum c...	2	2	0	10000
18	024 - Actuator 2 output maximum c...	5	5	0	10000
20	025 - Actuator 2 output maximum c...	8000	8000	0	10000
22	026 - Actuator 2 output maximum c...	2	2	0	10000
24	013 - Natural ventilation full stroke p...	10	10	0	10000
26	014 - Natural ventilation full stroke p...	400	400	0	10000
28	017 - Natural ventilation movement	0	0	0	10000
30	011 - BMS demand source	0	0	0	10000
32	013 - BMS input destination	0	0	0	10000
34	012 - BMS lock out period stroke p...	10	10	0	10000
36	021 - BMS analogue output stroke	11	11	0	10000
38	021 - Day To-Ep switch mode	0	0	0	10000
40	021 - Fire sensor mode	0	0	0	10000
42	042 - Fire sensor activation direction	1	1	0	10000

### Screenshot Of Parameters Page

The screenshot shows the SE CONTROLS Parameters page. At the top left is the SE CONTROLS logo. Below it is a small network diagram. The main area features a table of parameters with columns for ID, Parameter Name, Def. Value, Min, and Max Value. The table lists various system parameters such as 'Positional feedback mode', 'Positional reset count', and 'Shoulder pickup parameter'. A 'Get Parameters' dialog box is open, showing the current values for the selected parameters. On the right, there is a control panel for 'BPS10' with buttons for 'FL10', 'FL11', 'FL12', '0', '5', and '8', and status indicators for 'AMC0 - Analog Out' and 'PC00 - Position'.

ID	Parameter Name	Def. Value	Min	Max Value
2	011 - Positional feedback mode	0	0	Free
4	010 - Positional reset count	0	0	0000
6	407 - Positional compensation value	70	70	0040
8	015 - Shoulder pickup parameter	7000	7000	0000
10	019 - Current trip mode	0	0	Stop
12	021 - Actuator 1 output switching m...	0	0	Full
14	022 - Actuator 1 output maximum c...	8000	8000	0040
16	023 - Actuator 1 output maximum c...	2	2	0000
18	021 - Actuator 2 output switching m...	0	0	Full
20	022 - Actuator 2 output maximum c...	8000	8000	0040
22	023 - Actuator 2 output maximum c...	2	2	0000
24	013 - Natural ventilation full stroke p...	10	10	0000
26	014 - Natural ventilation full stroke d...	400	400	0000
28	017 - Natural ventilation movement...	0	0	Stop
30	021 - BPS demand source	0	0	TV s...
32	013 - BPS input control type	0	0	Auto
34	012 - BPS lock out period afterwa...	60	0	0000
36	021 - BPS analogue output enable	11	11	Full
38	021 - Day To Day switch mode	0	0	Auto
40	021 - Fan sensor mode	0	0	Stop
42	042 - Fan sensor activation direction	1	0	Clear

### Screenshot Of Events Page

This screenshot shows the SE CONTROLS Events page. The layout is identical to the Parameters page, but the 'Events' tab is selected in the top navigation bar. The table of parameters and the right-hand control panel for 'BPS10' are the same as in the Parameters page screenshot.

# OS2 SHEVTEC<sup>®</sup> Control Panel

## The OS2 SHEVTEC Controller is an intelligent 24V dc control system designed to drive 2-wire 24V dc actuators in a smoke control and/or environmental ventilation system

Operating from a 230V ac 5A supply, the OS2 SHEVTEC controller can deliver up to 8A to drive 24v motorised actuators and magnetic catches. Battery backup is provided for continued operation after a mains supply failure. Each controller can be mounted locally to the devices or in a centralised location. Each controller can operate independently or be linked to others to produce a networked control system. The networked control system can operate standalone or be linked to a Building Management System (BMS)

### Networked Control System

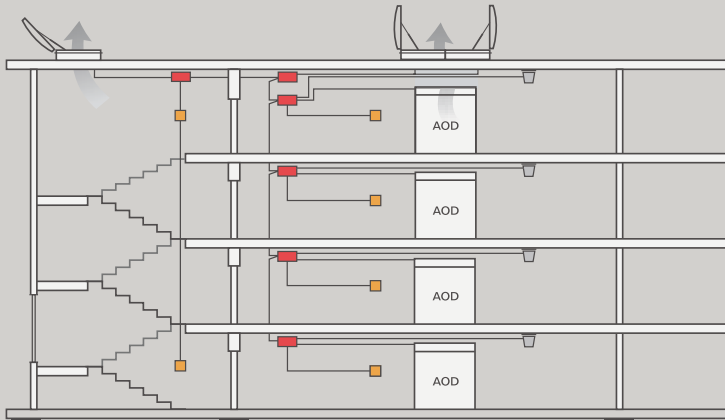

### Centralised Control System

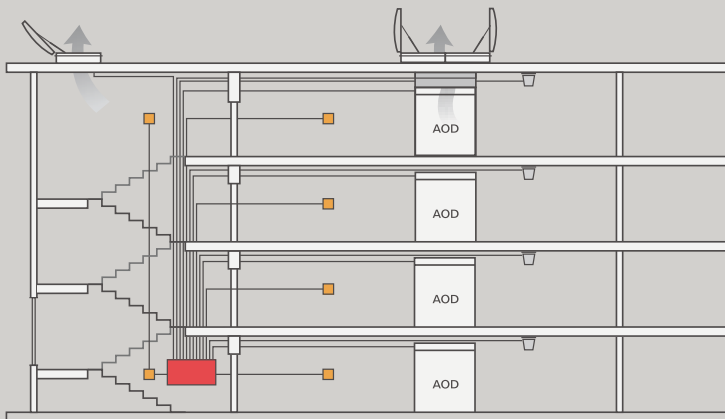

### Applications

-  Environmental Ventilation
-  Smoke Ventilation



### Accreditations

-  CE Certified Compliant to applicable regulations

### Finish

-  Unit comes in a standard GREY Powder coated enclosure

### Key

-  OS2 SHEVTEC Controller
-  Optical Smoke Detector
-  Manual Control Point

# OSLoop Coordinator

**OSLoop is a modular smoke control product that consists of a centralised coordination module and can control between 1 and 15 remotely mounted manual control points (MCPs). Larger systems can be constructed by linking together multiple coordinators, allowing the control of up to 64 MCPs.**

The coordinator controls power and data to the networked system, fully monitoring primary (mains) and secondary (battery) power supplies. The OSLoop system intelligently monitors current requirements of the system and determines how and when the MCPs require power to activate the AOVs.

Each MCP contains actuator switching circuitry which also monitors the actuator cabling and circuitry for faults. If a fault is detected, then the MCP raises a local alarm and also signals the coordinator so the remote alarms can be triggered. The MCP also provides support for one or more smoke detectors and monitors the detectors and cabling, checking for faults. In addition the MCP can be configured as master/slave device to other MCPs in the same system.

- System power is delivered via the Manual Control Point reducing the power supply and cable requirements
- 40% less cable costs than a conventional system
- 50% less devices compared to conventional systems
- Reduced system installation time
- prEN 12101-9 and EN 12101-10
- EMC tested to EN61000-6-2 and EN61000-6-3
- LVD tested to EN60335-1 as amended by EN60335-2-103.

## OSLoop Control System

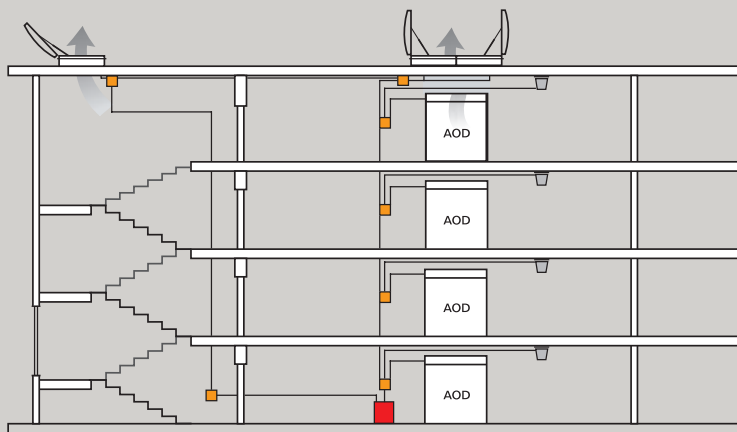

### Applications



Smoke Ventilation

### Accreditations



CE Certified Compliant to applicable regulations

### Finish



Unit comes in a standard GREY Powder coated enclosure

### Key



OSLoop Coordinator



Optical Smoke Detector



Manual Control Point

# OS2 SHEVTEC® System Wiring

## Roof

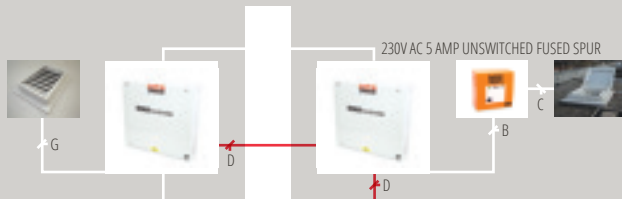

## 3rd Floor



## 2nd Floor

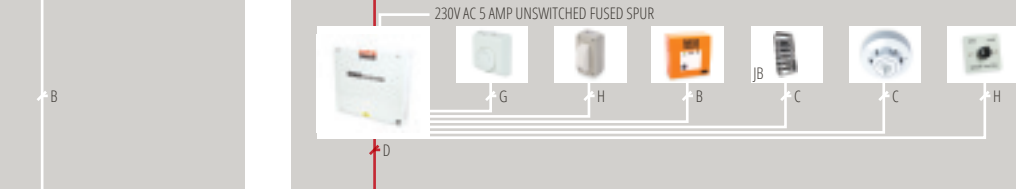

## 1st Floor

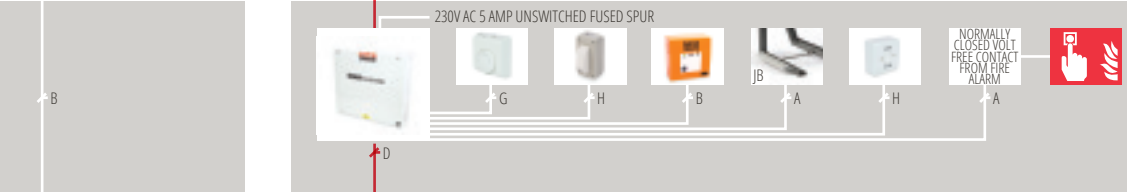

## Ground Floor

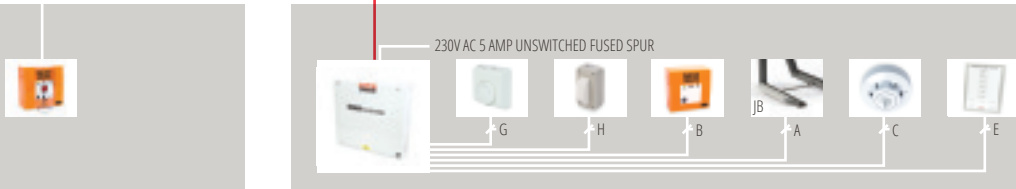

A	2 Core + Earth x 2.5mm <sup>2</sup> FP 200 Gold by others	C	3 Core + Earth x 1.5mm <sup>2</sup> FP 200 Gold by others	E	4 Core + Screen x 1.5mm <sup>2</sup> FP 200 Gold by others	G	2 Core + Earth x 1.5mm <sup>2</sup> LSF/PVC cable by others
B	5 Core x 1.5mm <sup>2</sup> FP 200 Gold by others	D	2 Core + Screen x 1.5mm <sup>2</sup> FP 200 Gold by others	F	Not Used	H	3 Core + Earth x 1.5mm <sup>2</sup> LSF/PVC cable by others

# OSLoop System Wiring

Roof



4th Floor



3rd Floor



2nd Floor



1st Floor



Ground Floor



A | 2 Core + Earth x 2.5mm<sup>2</sup> FP 200 Gold by others  
 B | 4 Core + Earth x 2.5mm<sup>2</sup> FP 200 Gold by others

C | 2 Core + Earth x 1.5mm<sup>2</sup> FP 200 Gold by others  
 D | 4 Core + Screen x 1.5mm<sup>2</sup> FP 200 Gold by others

E | Not used

# SHEV Systems

## SE Controls can provide a mechanical smoke ventilation system designed as an alternative solution to ADB and BRE smoke shafts.

Mechanical solutions can offer reduced smoke shaft sizes (typical 0.6m<sup>2</sup> versus 1.5m<sup>2</sup> or 3m<sup>2</sup>) increasing the lettable areas in a development. In addition, a mechanical system in conjunction with CFD modelled fire engineered solutions, offer increased escape travel distances reducing the need to include additional stair cores.

This type of system has been designed for both means of escape and fire fighting operation with occupants and fire & rescue service safety to the fore.

### Extended Escape Travel Distance System

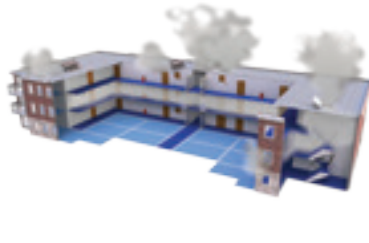

### Cfd Modelling Analysis

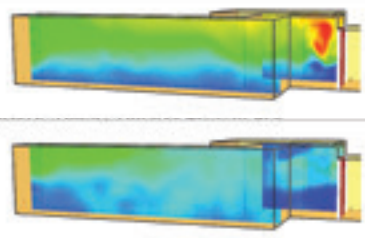

### The Effect On Hallways By Rapidly Clearing Smoke

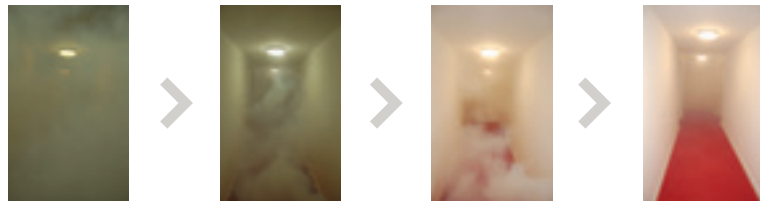

### Location Of Products In Typical Building

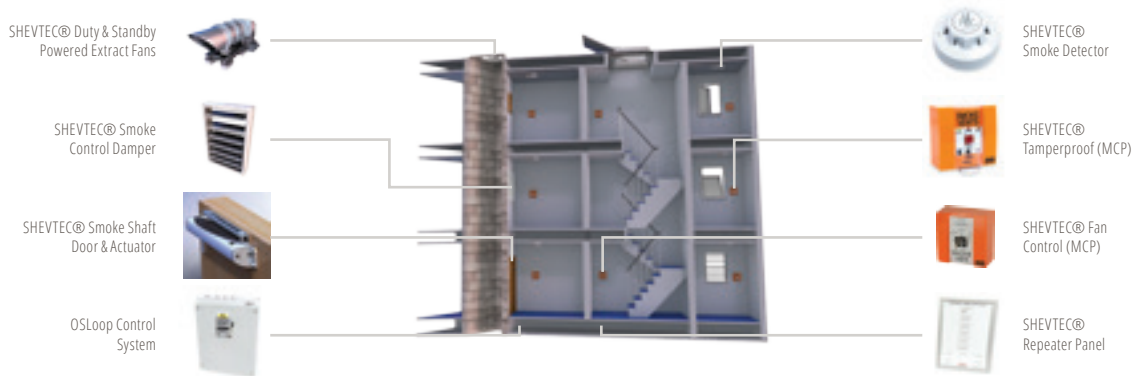

# Powered Fan Systems

Regardless of the structure and constraints of the available building space, SE Controls offers a range of solutions that can be tailored to meet all specifications

This includes mechanical extraction systems which can facilitate the need for smaller openings and a narrower shaft space, releasing valuable rentable floor space.

## Typical Schematic

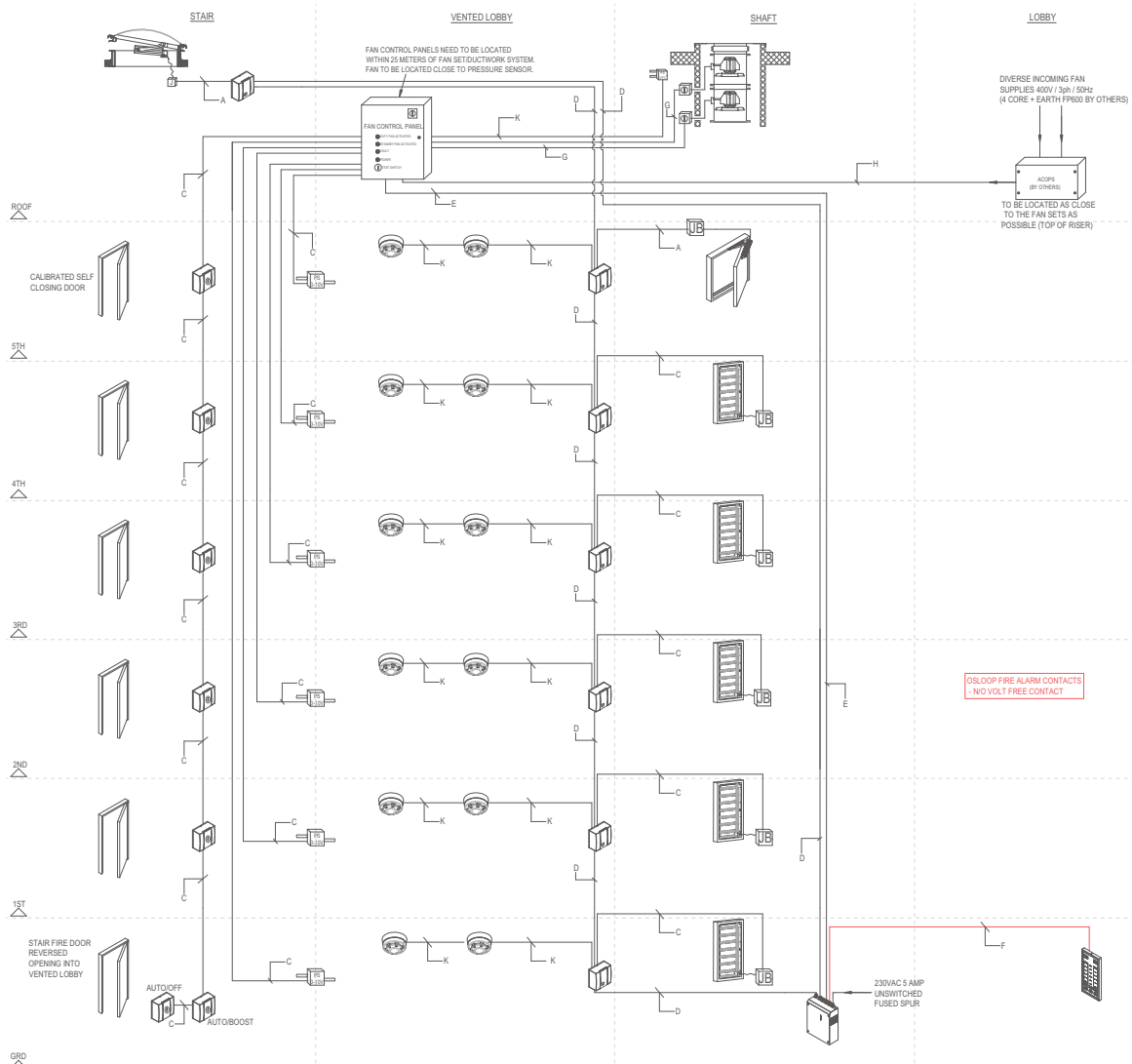

# Single Speed Fan Panel

## Controller / 415V 3Ph / 50Hz

The Fan Control Panel has the following features:

- Duty fan and standby fan control via fan pressure switch
- External fire fighters control (Auto/Off)
- Simple hard wired activation
- System state indication on panel face via LED's
- Activation/healthy vfc's for BMS monitoring
- Fan panel status can be viewed via associated SHEVTEC repeater panel

## Power

- Class 1
- Supply 415V 3Ph/50Hz from external ACOPS unit
- Three pole isolating switch on panel face for service requirement
- Current rating up to 22.5A (11 kW)
- Spike current tolerance is x 7 max current rating

## Environment

- IP rating 32
- Humidity 10 to 90% non-condensing
- Storage -20 to +75C
- Operating temperature -5 to 40C

## Miscellaneous

- Weight from 21kg
- Dimension 500 x 500 x 200 mm (H x W x D)

## Product Codes

Fan Panel	FCS 0022 0000
Fan Panel with Visual Indication	FCS 0022 0020



## Technical Drawing

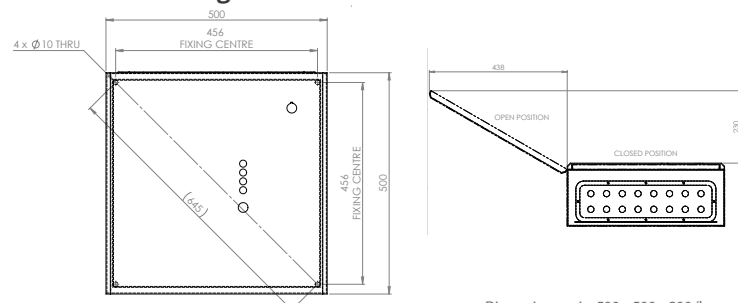

## Applications



Smoke  
Ventilation

## Accreditations



CE Certified Compliant to  
applicable regulations

# Variable Speed Fan Panel

## Controllers / 415V 3Ph/ 50Hz

The Fan Control Panel has the following features:

- Industrial PLC logic driven system
- Duty fan and standby fan control
- Multiple fan speed control via industrial inverter enabling fire fighting and/or means of escape operational mode
- External fire fighters key switch control (auto/off, auto/boost)
- Simple hard wired activation or more involved network signal activation
- Multiple panels can be networked together creating highly specialised multiple fan operation for multiple shafts
- Reversible fan operation if required for twin shaft/triple shaft push/pull systems
- Pressure sensor monitoring to prevent excessive negative pressure in the activated zone
- Ability to utilise duty/standby fans as NV fans for day to day operation
- Ability to power additional single phase or three phase NV fans
- Ductwork damper(s) control
- System state indication on panel face via LED's
- Activation/healthy v/c's for BMS monitoring
- Fan panel status can be viewed via associated SHEVTEC repeater panel

## Power

- Class 1
- Single 415V 3Ph/50Hz from external ACOPS unit or primary and secondary 415V 3Ph 50Hz supplies into internally fitted ACOPS unit
- Four pole isolating switch on panel face for service requirement
- Current rating up to 60A, current draw between 1 to 60A depending on either quiescent state or system activated state and associated fan FLC



## Technical Drawing



## Environment

- IP rating 54 (can be externally mounted with IP rating of 55)
- Internal or external panel fitting option
- Humidity 10 to 90% non-condensing
- Storage -20 to +75°C
- Operating temperature 0 to 35°C (internally climate controlled via internal cooling fan and/or enclosure heater)
- Fully weatherproofed where required

## Miscellaneous

Note: The below are all dependant on a variety of factors, including, but not limited to, system specification, inverter size, ACOPS requirements, additional NV fan control and panel location.

- Weight from 50kg up to 150kg
- op/bottom cable entry dependant on panel location

## Product Codes

Fan Control Panel FCS0025XXXX

## Applications



Environmental Ventilation

Smoke Ventilation

## Accreditations



CE Certified Compliant to applicable regulations

# NVLogiQ™ Indoor Air Quality

Independent research has demonstrated that moderate levels of CO<sub>2</sub> have a negative impact on the cognitive functions of the inhabitants of a given environment.

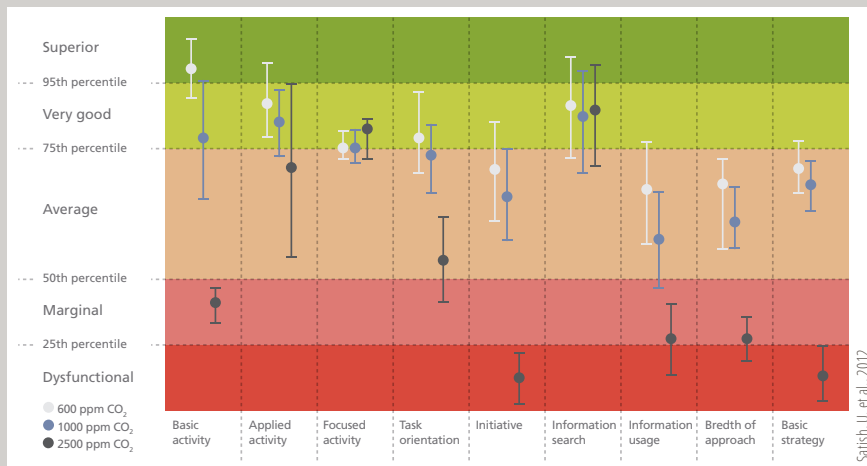

## Effect Of Not Having Automated Control

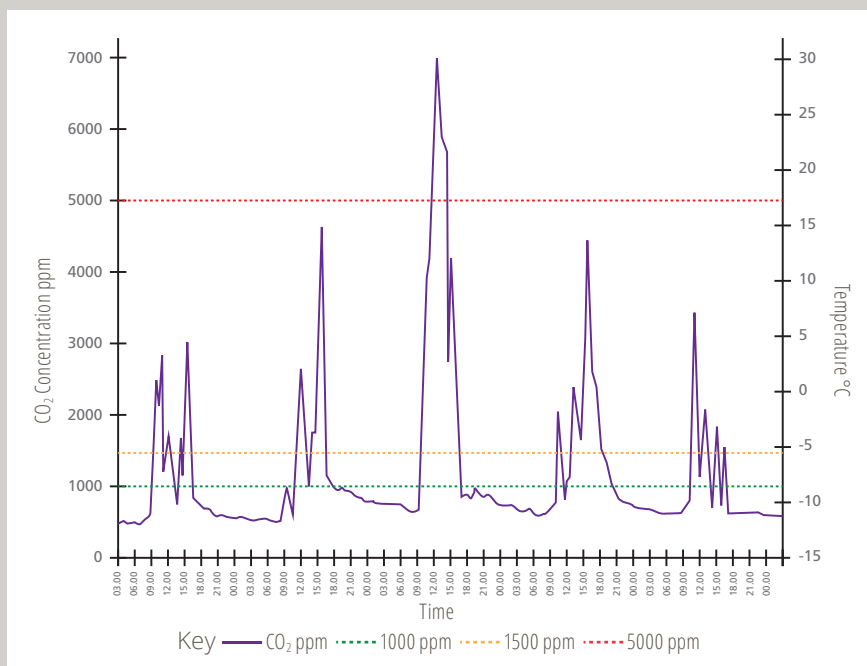

# NVLogiQ™ Room Controller

**NVLogiQ allows remote monitoring of the installation and can be used to demonstrate the current room conditions over a period to several month to help justify the need for an automated system.**

Once installed, the system can be used to monitor the current air quality and can be downloaded as an easy to read graph which shows a range of readings including CO<sub>2</sub>, temperature and vent position.

## Remote Monitoring Areas

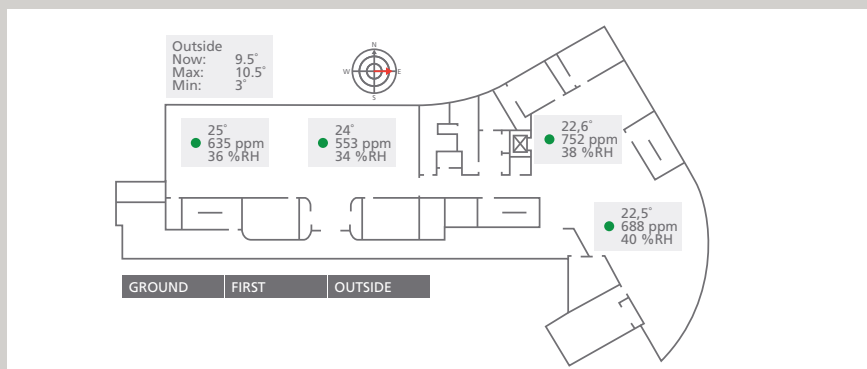

## Effect Of Having Automated Controls

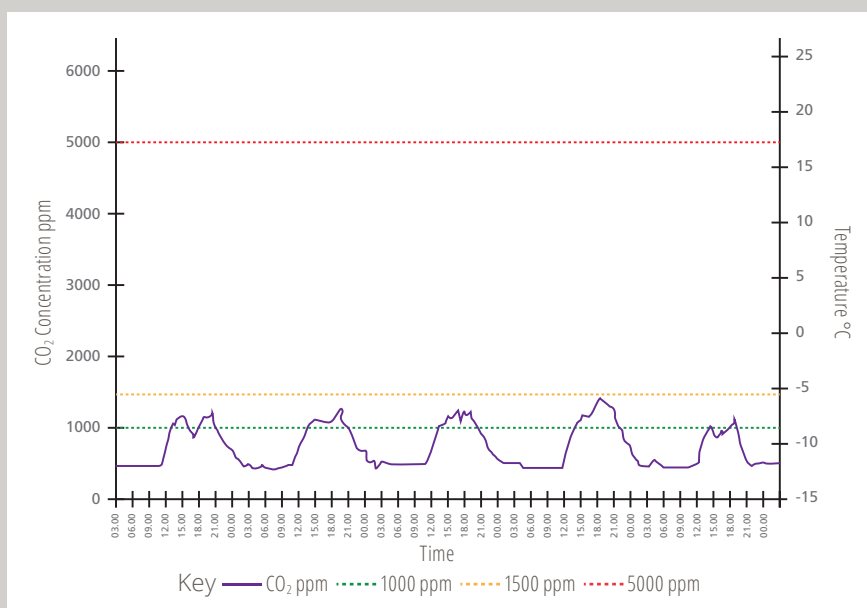

# NVLogiQ™ Room Controller

## Features

The NVLogiQ™ Room Controller has been designed to offer an effective, efficient and user friendly solution for adaptive environmental ventilation applications that is easily integrated into a new or refurbished building.

The NVLogiQ™ Room Controller can be used as a standalone system or networked to give individual room control with global common signals such as wind, rain and security closing.

All within a small wall-mounted enclosure, the NVLogiQ™ Room Controller has integrated sensors, switches and a backlit LCD display that offers the following facilities without the need for separate sensors within the room:

- CO<sub>2</sub> monitoring and level display
- Temperature monitoring and level display
- Humidity monitoring and level display
- User control via inbuilt switches with ten increments of operation
- Output signal for external devices such as central heating control etc
- Lock out function to prevent misuse
- Time clock for strategy and security closing
- Vent position/open output signal
- Fresh air 'morning start' setting
- Intuitive menu for setpoint adjustment via a security dongle
- Continuous data logging for performance analysis

The NVLogiQ™ Room Controller is supplied with a pre-programmed natural ventilation control algorithm developed in partnership with Loughborough University's Building Energy Research Group.

The strategy was formulated by modelling hundreds of comparable scenarios in both education and commercial buildings in conjunction with industry recognised methods and data collected from environmental ventilation projects installed over several years by SE Controls.

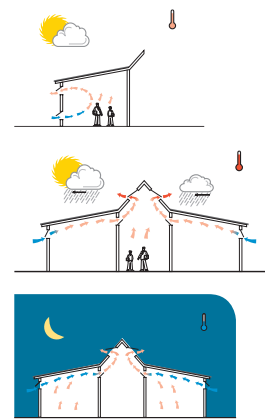

Requirements for regulations such as BB101 (internal environment for schools) and CIBSE Guides A have heavily influenced the design of the algorithms.

Dynamic Thermal Simulation models (DTS) and Computational Fluid Dynamics (CFD) were used to analyse the effectiveness and efficiency of the algorithm.

The system controls room CO<sub>2</sub> levels to a variable profile ensuring that Indoor Air Quality (IAQ) is optimised. The temperature control strategy increases the ventilation rate before internal temperature escalates and becomes uncontrollable. There are multiple temperature control strategies based on external temperature, and occupancy, which provide appropriate temperature control throughout the year.

A night purge strategy cools the building for a fresh start and can provide prolonged daytime cooling in buildings with sufficient thermal mass.

All settings are adjustable from standard or after the initial 'learning' period of occupancy.

Data logging is essential for pre or post occupancy performance analysis; the controller is capable of 3 month's recording of sensor readings and operation signals, and is downloadable using a dongle.

## POWER

- Class III
- Supply: Input: 24v DC
- Output: 0-10v and OSLink
- Real time clock battery average life 10 years
- ENVIRONMENT
- Rating: IP20
- Humidity Range: 10 to 90% non-condensing
- Storage: -20 to +50°C
- Operating temp: -10 to +50°C

## Miscellaneous

- Dimensions: 160 x 105 x 37 mm. Dia. 20mm top entry with cap and 58mm x 36mm rear entry

## Part Numbers

- NVLogiQ™ with CO<sub>2</sub> Part Number: NCS00020001
- NVLogiQ™ without CO<sub>2</sub> Part Number: NCS00020002

## Applications



Environmental  
Ventilation

## Accreditations



CE Certified Compliant to  
applicable regulations

# NVLogiQ™ PSU

## Technical Data

### Power

- Class 1
- Supply: 230V ac 50/60 Hz from a fused un-switched spur
- Input: 100-120VAC 3.5A / 200-240VAC 2.0A
- Note: For 115VAC operation, the mains input voltage selection switch must be set on the internal power supply.
- Output: 4.8A max actuator run current
- Note: Start up peak current needs to be considered and can vary depending on actuator type. Derate linearly to 70% load from +50 to +70°C.
- Real time clock battery average life 10 years

### Environment

- IP20
- Humidity Range: 10 to 90% Non-Condensing
- Storage: -20 to +75 °C
- Operating temp: -10 to +50 °C

### Miscellaneous

- Dimensions: 251.15 (excluding glands) x 191.2 x 56.3mm
- Cable entry: via five 20mm end mounted cable glands
- 0-10 Volts signals must remain stable and 'spike' free for a period of 2 seconds before the controller will respond to them. in 10% step mode, the controller only responds to 0-10V signals in steps of whole volts 250mV. In 5% step mode, each step is half a volt
- Derate linearly to 70% load at high temperatures.

### Part Numbers

- NVLogiQ PSU CONTROL PANEL 6A  
Part Number: NPS00010002



### Technical Drawing

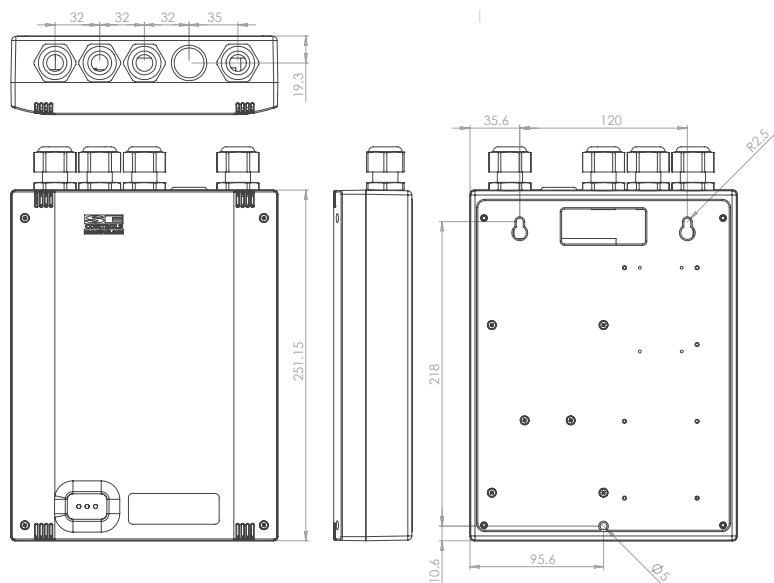

### Applications



Environmental  
Ventilation

### Accreditations



CE Certified Compliant to  
applicable regulations

# Manual Winding Gear

## Simple, inexpensive solution for environmental ventilation.

The 'Clearline' (Originally Teleflex) system is designed for out of reach windows in all buildings/markets: commercial, education, healthcare, residential and domestic.

The system entails a chain opener operated via a winding handle linked together by conduit and cable. Winding handles can be positioned to allow easy opening of hard to reach locations, while operating multiple vents via a single winding handle with a maximum cable run of up to 18 metres. This surface mounted application offers greater flexibility and compatibility with almost all window systems.

## Key Features

- Quality Engineered Stainless Steel Chain Openers.
- Up to 18m operation from Winding Handle to Chain Opener.
- Range of handle options to suit differing weight loads
- Low maintenance hard wearing system.
- Range of colours
- Product Manufactured in the UK.

## Details

Window Orientation	Max Cable Length	Control Device	Window Size One Push Point
BH00 	18m	Mini, Long Midi, Midi, Maxi	Up to Max 1100mm Wide. Min 250mm deep
TH00 	18m	Mini, Long Midi, Midi, Maxi	Up to Max 1100mm Wide. Min 250mm deep
Centre Pivot 	18m	Mini, Long Midi, Midi, Maxi	Up to Max 1100mm Wide. Min 250mm deep
Side Hung 	18m	Mini, Long Midi, Midi, Maxi	Up to Max 1100mm Wide. Min 250mm deep
BH01 	18m	Mini, Long Midi, Midi, Maxi	Up to Max 1100mm Wide. Min 250mm deep. Min 45mm head clearance required.
Roof Vent 	20m	Long Midi, Midi, Maxi	Approx 20kg.

## Colour Options

WHITE	RAL 9010
BLACK	RAL 9005
BROWN	RAL 8017
GREY	RAL 9006

## Configuration Options

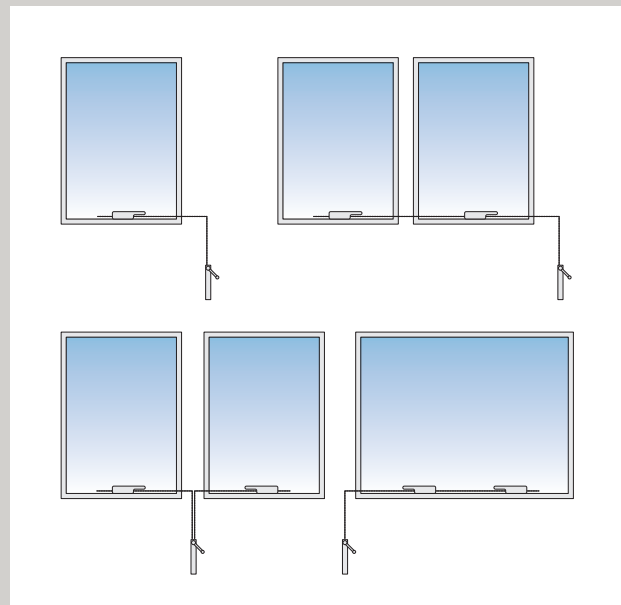

## Accessories

Core		
	1 x ROLL	EMK0010135C

Connectors		
	BLACK	EMK001018BL
	BROWN	EMK001018BR
	GREY	EMK001018GR
	WHITE	EMK001018WH

Conduit (3m lengths)		
	BLACK	EMK001012BL
	BROWN	EMK001012BR
	GREY	EMK001012GR
	WHITE	EMK001012WH

Saddle Packer		
	BLACK	EMK001016BL
	BROWN	EMK001016BR
	GREY	EMK001016GR
	WHITE	EMK001016WH

Saddle Clip		
	BLACK	EMK001015BL
	BROWN	EMK001015BR
	GREY	EMK001015GR
	WHITE	EMK001015WH

Saddle Base		
	WHITE	EMK0010145C

## Brackets

Fixing Plate 002 Metal		
	BLACK	EBT00010002
	BROWN	EBT00010004
	GREY	EBT00010003
	WHITE	EBT00010001

Fixing Plate 004 Wood/PVC		
	BLACK	EBT00020002
	BROWN	EBT00020004
	GREY	EBT00020003
	WHITE	EBT00020001

Open Inward Bracket		
	BLACK	EBT00030002
	BROWN	EBT00030004
	GREY	EBT00030003
	WHITE	EBT00030001

## Screw Jack Opener

	EMK001008W2
--	-------------

## Chain Opener

250mm		
	BLACK	EMK001006BL
	BROWN	EMK001006BR
	GREY	EMK001006GR
	WHITE	EMK001006WH

380mm		
	BLACK	EMK001007BL
	BROWN	EMK001007BR
	GREY	EMK001007GR
	WHITE	EMK001007WH

## Operating Handles

Long Midi Operator		
	BLACK	EMK01001BLL
	BROWN	NA
	GREY	EMK01001GRL
	WHITE	EMK01001WHL

Midi Operator		
	BLACK	EMK001001BL
	BROWN	EMK001001BR
	GREY	EMK001001GR
	WHITE	EMK001001WH

Maxi Operator		
	BLACK	EMK001000BL
	BROWN	EMK001000BR
	GREY	EMK001000GR
	WHITE	EMK001000WH

Mini Operator		
	BLACK	EMK001002BL
	BROWN	EMK001002BR
	GREY	EMK001002GR
	WHITE	EMK001002WH

100mm Handle		
	BLACK	EMK001003BL
	BROWN	EMK001003BR
	GREY	EMK001003GR
	WHITE	EMK001003WH

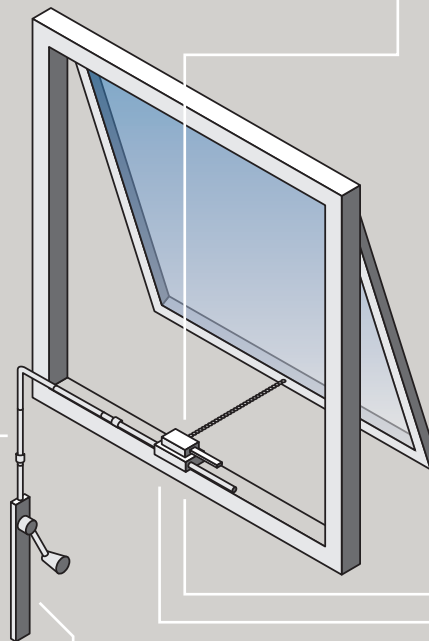

# OS2 SHEVTEC® Controller

## Power

- Supply: 230V ac 50/60 Hz from a 5A fused unswitched spur
- Output: nominal 24V dc 2-Channels combined output not to exceed 8A
- Backup battery: 2 x 12 V dc 7.0Ah sealed lead-acid batteries
- Battery standby time: 72 hours with maximum 40mA standby drain on PER permanent\*
- Expected battery life: 3+ years @ 25°C
- Real time clock battery life: 10 years

## Environment

- IP 30
- Humidity range: 10 to 90% Non-condensing
- Storage: -20 to +50°C
- Operating temperature for Control Panel (not including batteries): -5 to 40°C\*\*

## Miscellaneous

- Dimensions: 364.5 x 337.8 x 128.4mm
- Mass: approx 13kg
- Cable entry: via 15 x 20mm end mounted cable glands and/or one rear entry slot for concealed connection
- Internal temperature sensor installed to provide optimal battery charging compensation as the ambient temperature changes.

\*Standby drain current comprises of enabled fire inputs, communication cards, and other loads connected to PER.

\*\*Operation at elevated temperatures may reduce battery life.

## Product Codes

OS2 SHEVTEC Controller FCS12250000



## Technical Drawing

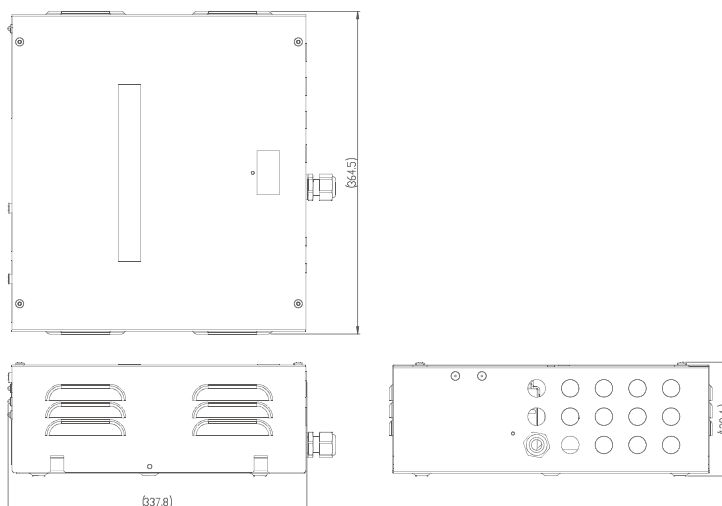

## Applications



Environmental  
Ventilation



Smoke  
Ventilation

## Accreditations



CE Certified Compliant to  
applicable regulations

# OS2 SHEVTEC® 30A PSU

## Power

- Supply: 230V ac 50/60 Hz from a 13A supply
- Output: Nominal 24V dc 4-channels output not to exceed 8A per channel
- Back up battery: 2 x 12V dc 22.0Ah sealed lead-acid batteries
- Battery standby time: 72 hours with maximum 100mA standby drain on PER permanent\*
- Expected battery life: 3+ years @ 25°C
- Real time clock battery life: 10 years
- 110/230V input

## Environment

- IP 30
- Humidity rating: 10-90% Non-condensing
- Storage: -20 to +50°C
- Operating temperature for control panel (not inc. batteries): -5 to +40°C\*\*

## Miscellaneous

- Dimensions: 600x400x250mm
- Mass: Approx with batteries 33.4kg, without batteries 20.2kg
- Cable entry: Via 32x20mm top mounted cable glands
- Internal temperature sensor installed to provide optimal battery charging compensation as the ambient temperature changes
- \*Standby drain current comprises of enabled fire inputs, communication cards and other loads connected to PER
- \*\*Operation at elevated temperatures may reduce battery life

## Product codes

- 30A PANEL with battery backup  
Part Number: FCS12001030
- Without battery backup  
Part Number: FCS12000031



## Enclosure Technical Drawing

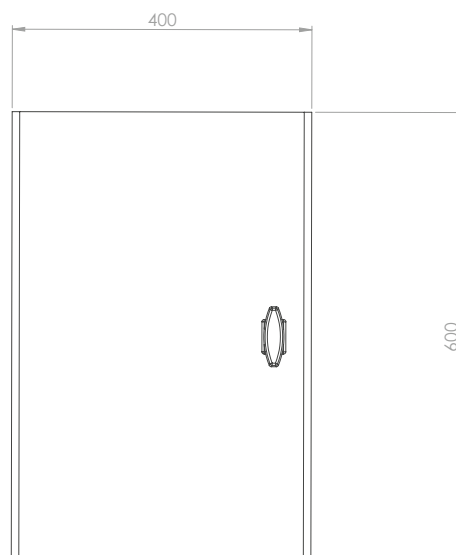

## Applications

-  Environmental Ventilation
-  Smoke Ventilation

## Accreditations

-  CE Certified Compliant to applicable regulations

# OSLoop Control System

## Features

- 40% less cable costs than a conventional system
- 50% less devices compared to conventional systems
- Reduced system installation time
- prEN 12101-9 and fully EN 12101-10 compliant
- EMC tested to EN61000-6-2 and EN61000-6-3
- LVD tested to EN60335-1 as amended by EN60335-2-103.

## Coordinator Specification

Part number	FCS00300010
Dimensions	310 x 380 x 130mm (W x H x D Approx.)
Mass Approx	4.1kg
Supply	230V AC, 50/60Hz @ 4A
Output VA	25.5VDC @7A continuous, 9A for 60 seconds
Output VB	27.6VDC @7A continuous, 10A for 60 seconds
VB Batteries	2x12VDC 12.0Ah Sealed Lead-Acid Batteries. (Operation at elevated temperatures may reduce battery life)
IP Rating	IP20
Humidity	10 to 90% Non-Condensing
Temperatures	20 to +75°C (storage) 0 to +40°C (operating)

## Manual Control Point (MCP) Specification

Standard MCP Part numbers	FCS00300027 (Complete unit) PYS15040061 (Surface mounted pattress box)
Tamperproof MCP Part Numbers	FCS00300028 (Complete unit) PYS15040061 (Surface mounted pattress box)
Dimensions	87 x 87 x 50mm (H x W x D Approx.)
Mass Approx	0.1kg
Supply	20V-29V DC @ 4A
Output	20V-29V @6A Max
IP Rating	IP20
Humidity	10 to 90% Non-Condensing
Temperatures	20 to +75°C (storage) 0 to +50°C (operating)

## Smoke Detector Specification

Part numbers	HEAD PART NO. ADA 55000318 OSLoop BASE PART NO. ADA 45681200
	FasTest takes just 4 seconds to test and confirm detectors are functioning correctly
	Responds well to slow-burning, smouldering fires
	Good performance in both black and white smoke

**Key**

- OSLoop Coordinator
- Optical Smoke Detector
- Manual Control Point

**Technical Drawing**

Manual Control Point (MCP)

Tamperproof Manual Control Point (MCP)

**Applications**

Smoke Ventilation

**Accreditations**

CE CE Certified Compliant to applicable regulations

# Smoke Detector

## Detector operating principles

Principle of detection: Photo-electric detection of light scattered by smoke particles over a wide range of angles. The optical arrangement comprises an infra-red emitter with a prism and a photo-diode at 90° to the light beam with a wide field of view.

## Details

- Flashing LED: The integral LED flashes when the detector is in a quiescent state.
- Supply Voltage: 9 to 33V DC
- Ripple Voltage: 2V peak to peak max at 0.1Hz to 100kHz
- Power-up Time: <20 seconds
- Alarm Current: 40mA
- Material: Detector and base moulded in white polycarbonate
- Terminals: Nickel plated stainless steel
- Dimensions: Detector 100 x 42mm, Detector in Base 100 x 50mm
- Weight: Detector 99g Detector in base 150g
- Temperature: Operating temperature -20°C to +60°C (no condensation or icing)
- Humidity: 0% to 95% relative humidity (no condensation)
- Atmospheric Pressure: Insensitive to pressure
- Wind Speed: Insensitive to wind
- IP 23

## Part Numbers

- HEAD PART NO. ADA 55000318
- OS2 BASE PART NO. ADA 45681245
- OSLoop BASE PART NO. ADA 45681200



## Applications



Smoke Ventilation

## Accreditations



CE Certified Compliant to applicable regulations

# Tamper Proof Manual Control Point (MCP)

## Details

- prEN 12101-9
- Provided in orange (RAL 2011) as required as part of prEN 12101-9
- The device has the capabilities to provide audible signals and faults along with having a silence button out of view
- The device continuously monitors actuators and connections to smoke detectors (As required as part of prEN 12101-9)
- Event logging to provide historical user information
- Maintenance indication (Statutory requirement of the Regulatory Reform Order (Fire Safety))
- Activation via access key fob
- Reset via access key fob
- Reset push button
- Activated LED
- Power/Healthy LED
- Fault LED

## For use with 24V OSLoop and OS2 control panels

- 87 x 87 x 22mm (h x w x d) - Flush mount
- 87 x 87 x 54mm (h x w x d) - Surface mount

## MCP part numbers

OSLoop MCP part number	Complete Unit	FCS00300028
OS2 MCP part numbers	MCP Module	FCS00200081
	Dumb Reset Key	FCS00200024
	MCP Activation Key	FCS00200033
	Surface Mount Box	FYS15040061



## Technical Drawing

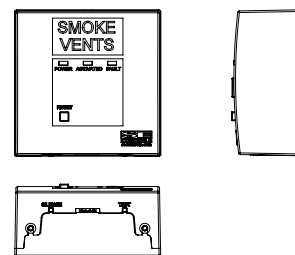

## OSLoop Control System

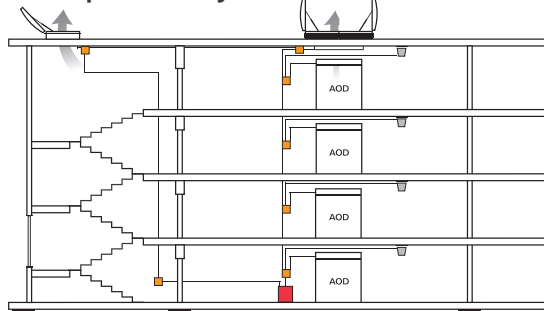

## OS2 Control System

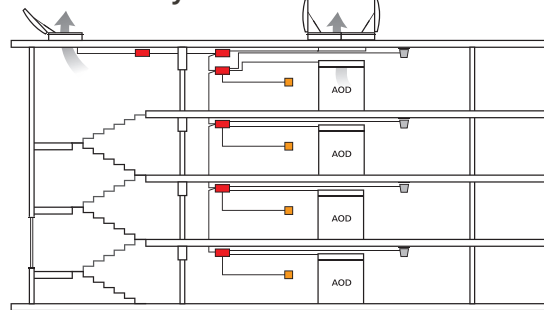

## Key

- OSLoop Coordinator / OS2 SHEVTEC Controller
- Optical Smoke Detector
- Manual Control Point

## Applications



Smoke  
Ventilation

## Accreditations



CE Certified Compliant to  
applicable regulations

# Manual Control Point (MCP)

## Details

- prEN 12101-9
- Provided in orange (RAL 2011) as required as part of prEN 12101-9
- The device has the capability to provide audible signals and faults along with having a silence button out of view
- The MCP (OSLoop version) continuously monitors actuators and connections to smoke detectors (As required as part of prEN 12101-9)
- Event logging to provide historical user information
- Maintenance indication (Statutory requirement of the Regulatory Reform Order (Fire Safety))
- Cover reset push button via access key fob
- Reset push button
- Activated LED
- Power/Healthy LED
- Fault LED
- Single action activation cover (replaces glass frangible element)

## For use with 24V OSLoop and OS2 control panels

- 87 x 87 x 22mm (h x w x d) - Flush mount
- 87 x 87 x 54mm (h x w x d) - Surface mount

## MCP part numbers

OSLoop MCP part number	Complete Unit	FCS00300027
OS2 MCP part numbers	MCP Module	FCS00200080
	Dumb Reset Key	FCS00200024
	Surface Mount Box	FYS15040061
	MCP Finger Plate	FCS00200055

## Technical Drawing

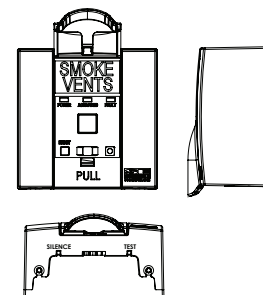

## OSLoop Control System

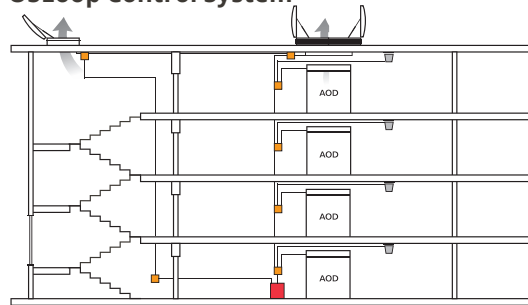

## OS2 Control System

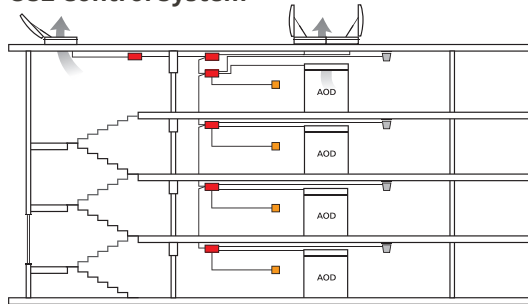

## Key

- OSLoop Coordinator / OS2 SHEVTEC Controller
- Optical Smoke Detector
- Manual Control Point

## Applications



## Accreditations



# 3A Transformer

## Details

The SE Controls 230V 3A Transformer is a reverse polarity transformer designed to drive 2-wire 24V dc actuators in an environmental ventilation system.

### Switched

This touch sensitive capacitive switch is a cost effective control mechanism that fits neatly into a standard double gang aperture.

### Unswitched

The unswitched version is a cost effective control mechanism that fits neatly into a standard double gang aperture.

## Technical Data

Voltage	230V dc / 50/60Hz (+/- 10%)
Power Consumption	Max 350mA
Fuses	1Amp
Voltage Output	24V +/-10%
Output Current	Max. 3Amp
Duty Cycle	1 min on/ 4 min off
Ingress Protection	IP50 din 40050
Housing	plastic, white for surface mounting
Dimensions	approx. 146 x 86 x 40mm ( w x h x d )
Ambient Temperature	0-40°C
Connecting Terminal	230V max. 1.5mm <sup>2</sup> 24V max. 1.5mm <sup>2</sup>
Application	Environmental

\*The product is to be fitted into a compatible MK manufactured double pattress box, with minimum depth of 47mm.

## Switched



## Unswitched



## Switched

Typical Connection Details:

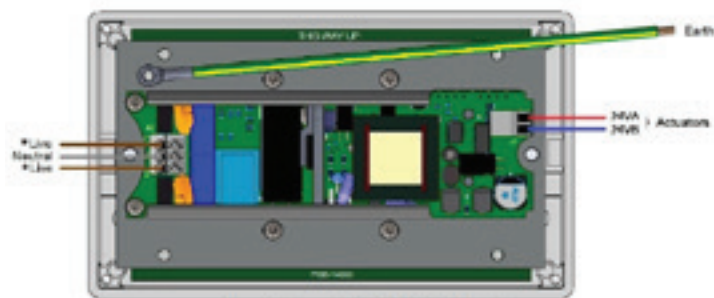

## Unswitched

Typical Connection Details:

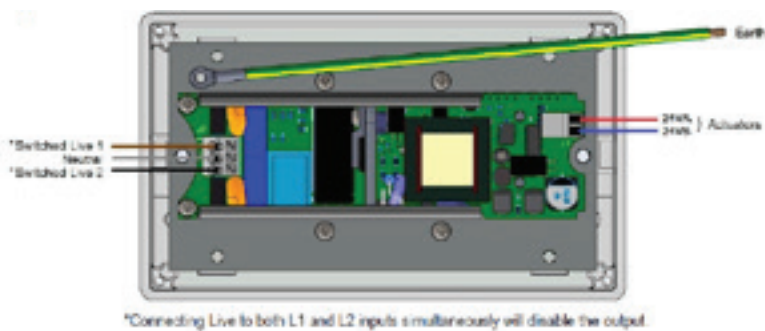

## Part Numbers

Product	Part No
3A Transformer - Fascia switched	FRS00010032
3A Transformer - Unswitched	FRS00010031

## Applications



Environmental  
Ventilation

## Accreditations



CE Certified Compliant to  
applicable regulations

# Open/Close Switches

## Surface Mounted

- Steel enclosure (80w x 80h x 51d mm) designed to be used with either a key switch or a paddle switch fitting.
- For either switch fitting, a range of switch position options are available:
- 3 positions
- Spring return
- Fixed position
- 2 position spring
- Designed for smoke ventilation applications. Instructional text is etched into the plate's surface for improved durability.

## Product codes

Open/Close Key Switch	ATSASSYOC01
Open/Close Smoke Vent Key Switch	ATSASSYSV03
Open/Close Window Control Key Switch	ATSASSYWC03
Open/Close Roof Vent Key Switch	ATSASSYRV03
Open/Close Paddle Switch	ATSASSYOC02
Open/Close Smoke Vent Paddle Switch	ATSASSYSV04
Open/Close Window Control Paddle Switch	ATSASSYWC04
Open/Close Roof Vent Paddle Switch	ATSASSYRV04
Open/Close Rocker Switch	ASM00000003

## Flush Mounted

- Brushed stainless steel face plate (86w x 86h x 2d mm) designed to be used with either a key switch or a paddle switch fitting.
- For either switch fitting, a range of switch position options are available:
- 3 positions
- Spring return
- Fixed position
- 2 position spring
- Designed for smoke ventilation applications. Instructional text is etched into the plates surface for improved durability.

## Product Codes

Open/Close Key Switch	ATSASSYOC04
Open/Close Smoke Vent Key Switch	ATSASSYSV01
Open/Close Window Control Key Switch	ATSASSYWC01
Open/Close Roof Vent Key Switch	ATSASSYRV01
Open/Close Paddle Switch	ATSASSYOC05
Open/Close Smoke Vent Paddle Switch	ATSASSYSV02
Open/Close Window Control Paddle Switch	ATSASSYWC02
Open/Close Roof Vent Paddle Switch	ATSASSYRV02
Open/Close Rocker Switch	ASM00000001

## Surface Mounted

### Key Version



### Paddle Version



### Rocker Version



## Flush Mounted

### Key Version



### Paddle Version



### Rocker Version



## Applications



Environmental Ventilation



Smoke Ventilation

## Accreditations



CE Certified Compliant to applicable regulations

# SECO Ni 24 40

## Technical Data

Actuator	SECO Ni 24 40
Actuator Type	24V dc Chain Opener
Voltage (All +/-5%)	24V dc
Current Draw (Amp)	0-600mm= 1.0A 601-900mm= 1.2A
Stroke	0-600mm (configurable) 601-900mm (configurable)*
Operating Speed	15mm/sec min. 5mm/sec (configurable)
Ambient Operating Temp	-5°C to +60°C
Thrust Force	400N
Close Force	400N
Soft Close	Yes
Switching	Electronic
Standard Finish	Powder coated Grey (RAL 9006)
Seal Relief	Programmable up to 20mm
Clamping Force	4000N
Colour Option	Other RAL colours available on request
Flex Length	2m
Flex Type	2 core/ 0.75mm silicone 4 core (volt free contact) as option
Flex Colour	Grey
Product Warranty	15,000 cycles
Duty Cycle	22% (2 mins on, 7 mins off)
Protection Degree	IP20
Bracket	Sill fixing/ open inward/ face fix bracket
Synchronisation	Optional
Application	Smoke and Environmental Ventilation

## Dimensions

DIM X (mm)	STROKE (mm)
635	up to 600
785	601-900



## Technical Drawing

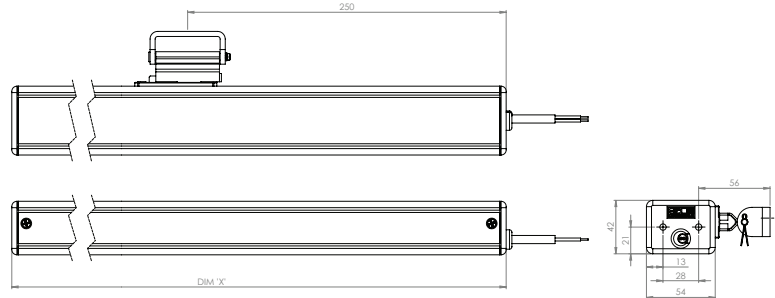

## Product Codes

Silver Grey (Ral 9006)	Operating Voltage	Force	Stroke
AASI400600S	24V	400N	600mm
AASI400900S	24V	400N	900mm

## Bracket Product Codes

Height (mm)	Offset (mm)					
	0	5	8	10	15	20
35	AKS16000001	AKS16050001	AKS16080001	AKS16100001	AKS16150001	N/A
40	AKS16000002	AKS16050002	AKS16080002	AKS16100002	AKS16150002	N/A
50	AKS16000003	AKS16050003	AKS16080003	AKS16100003	AKS16150003	AKS16200003

## Applications



Environmental  
Ventilation



Smoke  
Ventilation

## Accreditations



CE Certified Compliant to  
applicable regulations

# Twin SECO Ni 24 40

## Technical Data

Actuator	Twin SECO Ni 24 40
Actuator Type	24V dc Chain Opener
Voltage (All +/-5%)	24V dc
Amp Draw Current (With Load)	0-600mm= 2.0A 601-900mm= 2.4A
Stroke	0-600mm (configurable) 601-900mm (configurable)*
Operating Speed	15mm/sec min. 5mm/sec (configurable)
Ambient Operating Temp	-5°C to +60°C
Thrust Force	2 x 400N
Close Force	2 x 400N
Soft Close	Yes
Switching	Electronic
Standard Finish	Powder coated Grey (RAL 9006)
Seal Relief	Programmable up to 20mm
Clamping Force	4000N
Colour Option	Other RAL colours available on request
Flex Length	2m
Flex Type	2 core/ 0.75mm silicone 4 core (volt free contact) as option
Flex Colour	Grey
Product Warranty	15,000 cycles
Duty Cycle	22% (approx. 2 mins on, 7 mins off)
Protection Degree	IP20
Bracket	Sill fixing/ open inward/ face fix bracket
Synchronisation	Optional
Application	Smoke and Environmental Ventilation

## Dimensions

DIM X (mm)	DIM Y (mm)	STROKE (mm)
1295.5	753.5	up to 600
1592.5	1050.5	601-900



## Technical Drawing

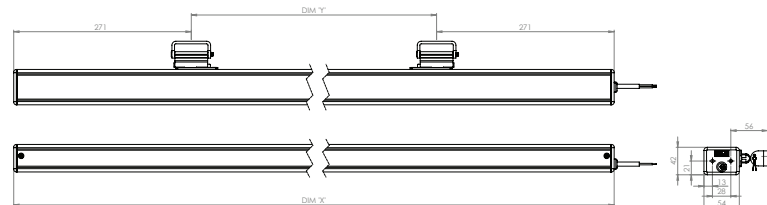

## Product Codes

SILVER GREY (RAL 9006)	OPERATING VOLTAGE	FORCE	STROKE
AAST140600S	24V	2 x 400N	600mm
AAST140900S	24V	2 x 400N	900mm

## Bracket Product Codes

	Offset (mm)					
Height (mm)	0	5	8	10	15	20
35	AKS16000001	AKS16050001	AKS16080001	AKS16100001	AKS16150001	N/A
40	AKS16000002	AKS16050002	AKS16080002	AKS16100002	AKS16150002	N/A
50	AKS16000003	AKS16050003	AKS16080003	AKS16100003	AKS16150003	AKS16200003

## Applications



## Accreditations



# SECO N 24 25

## Technical Data

Actuator	SECO N 24 25
Actuator Type	24V dc Chain Opener
Voltage (All +/-5%)	24V dc
Current Draw (Amp)	<0.5A
Stroke	250mm, 350mm (configurable)
Operating Speed	5mm/sec (configurable) 3mm/sec (option single application only)
Ambient Operating Temp	-5°C to +60°C
Thrust Force	250N
Close Force	250N
Soft Close	Yes
Switching	Electronic
Standard Finish	Powder coated Grey (RAL 9006)
Seal Relief	Programmable up to 20mm
Clamping Force	4000N
Colour Option	Other RAL colours available on request
Flex Length	2m
Flex Type	2 core PVC 4 core (volt free contact)* as option
Flex Colour	Grey
Product Warranty	15,000 cycles
Duty Cycle	22% (approx. 2 mins on, 7 mins off)
Protection Degree	IP20
Bracket	Sill fixing/ face fix/ thru body sill
Synchronisation	Optional
Application	Environmental Ventilation



## Standard bracket detail

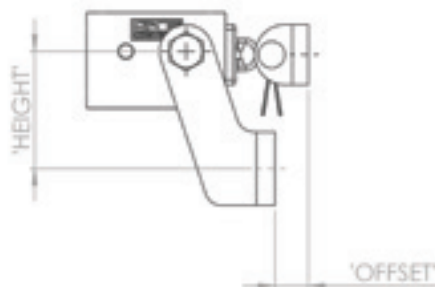

## Technical Drawing

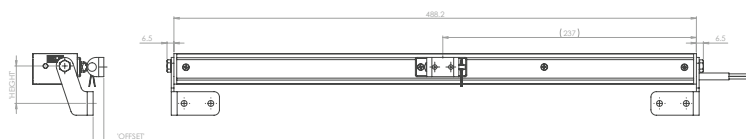

## Product Codes

Silver Grey (Ral 9006)	Operating Voltage	Force	Stroke
AAS0250250S	24V	250N	250mm
AAS0250350S	24V	250N	350mm

## Bracket Product Codes

Height (mm)	Offset (mm)					
	0	5	8	10	15	20
35	AKS1800001	AKS18050001	AKS18080001	AKS18100001	AKS18150001	N/A
40	AKS1800002	AKS18050002	AKS18080002	AKS18100002	AKS18150002	N/A
50	AKS1800003	AKS18050003	AKS18080003	AKS18100003	AKS18150003	AKS18200003

## Applications



Environmental  
Ventilation

## Accreditations



CE Certified Compliant to  
applicable regulations

# Twin SECO N 24 25

## Technical data

Actuator	Twin SECO N 24 25
Actuator Type	24V dc Chain Opener
Voltage (All +/-5%)	24V dc
Amp Draw Current	<1.0A
Stroke	350mm other strokes are available*
Operating Speed	min. 5mm/sec (configurable)
Ambient Operating Temp	-5°C to +60°C
Thrust Force	2 x 250N
Close Force	2 x 250N
Soft Close	Yes (via adjustable zero point setting)
Switching	Electronic
Standard Finish	Powder coated Grey (RAL 9006)
Seal Relief	Programmable up to 20mm
Clamping Force	2 x 4000N
Colour Option	Other RAL colours available on request
Flex Length	2m
Flex Type	2 core PVC 4 core (voltage free contact)* as option
Flex Colour	Grey
Product Warranty	15,000 cycles
Duty Cycle	22% (approx. 2 mins on, 7 mins off)
Protection Degree	IP20
Bracket	Sill fixing/ face fix/ thru body sill
Synchronisation	Optional
Application	Environmental Ventilation

## Dimensions

DIM X (mm)	DIM Y (mm)	STROKE (mm)
1131	497	Max. 350
1309	675	Max. 350
1359	725	Max. 350

## Standard Bracket Detail

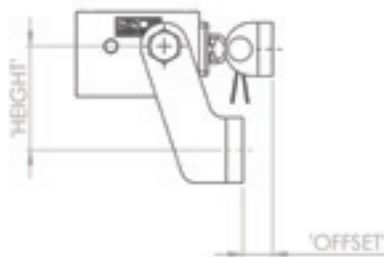

## Technical Drawing

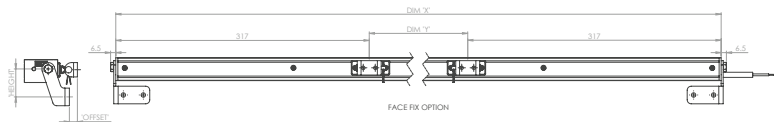

## Product Codes

Silver Grey (Ral 9006)	Operating Voltage	Force	Stroke	Actuator Body Length	To Suit Vent Length
AAST250350S	24V	250N	350mm	1131mm	1150mm
AAST251350S	24V	250N	350mm	1309mm	1350mm
AAST252350S	24V	250N	350mm	1359mm	1450mm

## Bracket Product Codes

Height (mm)	Offset (mm)					
	0	5	8	10	15	20
35	AKS1800001	AKS1805001	AKS1808001	AKS1810001	AKS1815001	N/A
40	AKS1800002	AKS1805002	AKS1808002	AKS1810002	AKS1815002	N/A
50	AKS1800003	AKS1805003	AKS1808003	AKS1810003	AKS1815003	AKS1820003

## Applications



Environmental Ventilation

## Accreditations



CE Certified Compliant to applicable regulations

# Brackets

## Series 40 Brackets

Face Fix Brackets For The SECO Ni 40 Actuator Range

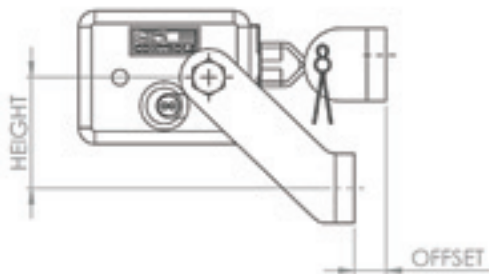

### Bracket Product Codes

Height (mm)	Offset (mm)					
	0	5	8	10	15	20
35	AKS16000001	AKS16050001	AKS16080001	AKS16100001	AKS16150001	N/A
40	AKS16000002	AKS16050002	AKS16080002	AKS16100002	AKS16150002	N/A
50	AKS16000003	AKS16050003	AKS16080003	AKS16100003	AKS16150003	AKS16200003

## Series 25 Brackets

Face Fix Brackets For The SECO N 25 Actuator Range

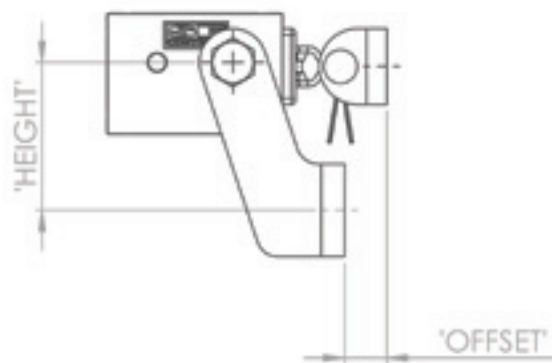

### Bracket Product Codes

Height (mm)	Offset (mm)					
	0	5	8	10	15	20
35	AKS18000001	AKS18050001	AKS18080001	AKS18100001	AKS18150001	N/A
40	AKS18000002	AKS18050002	AKS18080002	AKS18100002	AKS18150002	N/A
50	AKS18000003	AKS18050003	AKS18080003	AKS18100003	AKS18150003	AKS18200003

# Smoke Shaft Door Actuator & Door opener

## Door opener

Type	Actuator
Usage	Smoke Ventilation
Voltage	24V dc
Current	0.5A
Max Force	2000N
Speed with Nominal Load	Door to open to 90° within 60 seconds
Operating Temperature	In line with EN 12101-2:2003 Annex G
Life Cycle	5000
Flex	2 core silicone
Switching	Electronic
Type of Switch	Positional Limiting
Fixing options	Door or frame
IP rating	IP20
Intumescent seal within actuator	Situated around mounting bracket

## Fire Rated Smoke Door

Type	Door
Usage	Smoke ventilation
Fire Rating	FD30
Intumescent seal around door	Head and Jamb of frame reveal
Smoke/Intumescent seal	Acoustic Smoke Seal & Intumescent Seal comes as standard

## Product / Solution Compliance

SHEVTEC® Smoke Shaft Actuator and Door	Principles of EN 12101-2: 2003 Annex G - Door to operate after 5 minutes at 300° and open the door to 90° and remain open for 30 minutes
SHEVTEC® Door	BS EN 1363: Part 1: 1999 - Maintain temperature / time relationship during test and not breach the doors integrity within 30 minutes
SHEVTEC® Door	Principles of BS EN 1634:1 - Maintain temperature / time relationship during test and not breach the doors integrity within 30 minutes
Intumescent / Smoke Seals	In accordance to BS 476: part 31: section 31.1
Door frame	BS EN 942:1996 - Specification of material and minimum density



### Applications



Smoke Ventilation

### Accreditations



CE Certified Compliant to applicable regulations

# SELA T 24 100 SYNCHRO

## Linear Actuator/ 24V dc/ 1000N

Cost effective and strong rack and motor drive mainly used for sloping smoke vent and rooflight applications.

Two actuators are used in tandem (fully synchronised), providing two push points on the same vent removing the need for a separate synchronisation unit.

Tested to EN 12101-2 smoke vent standard with specific incline system profiles. Contact SE Controls for selection advice.

NB: 24V actuators require control from a compatible low voltage unit such as an OS2 SHEVTEC Controller or NVLogiQ® PSU and **permanent power should not be applied.**

## Technical Data

ACTUATOR	SELA T 24 100 SYNCHRO
ACTUATOR TYPE	24V dc Rack & Pinion Linear Actuator
VOLTAGE (all +/-5%)	24V dc
CURRENT DRAW (Amp)	2 x 1.5A
STROKE	350, 550, 750, 1000*mm
OPERATING SPEED	12.5mm/s
AMBIENT OPERATING TEMP	-10°C to +40°C
THRUST FORCE	1000N
CLOSE FORCE	1000N
SWITCHING	Electronic
STANDARD FINISH	Silver anodised
COLOUR OPTION	N/A
FLEX LENGTH	1.5m
PRODUCT WARRANTY	10,000 cycles
DUTY CYCLE	25 %
IP RATING	IP65
BRACKET	End and Sliding Bracket
SYNCHRONISATION	Yes
APPLICATION	Smoke and Environmental Ventilation

\*Not sub 60 seconds

## Dimensions

Stroke	Length
350mm	523mm
550mm	723mm
750mm	923mm
1000mm	1173mm

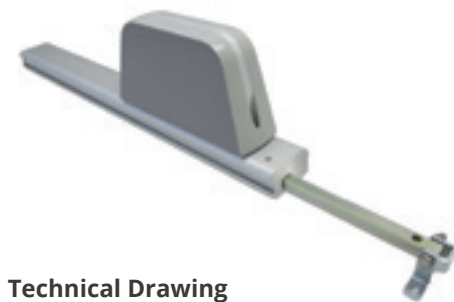

## Technical Drawing

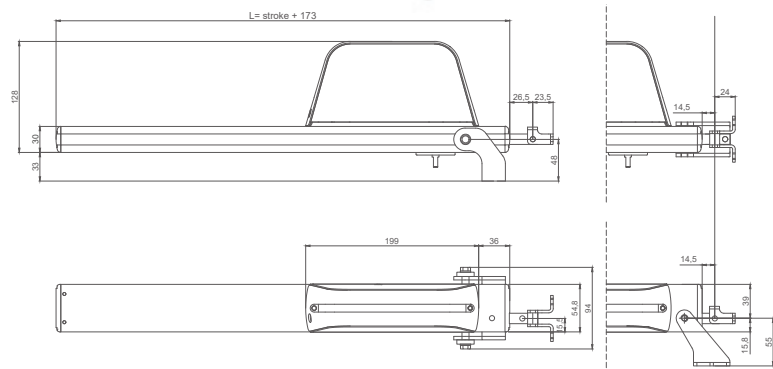

## Brackets

SELA T Aluminium End Bracket AAU0141760Y

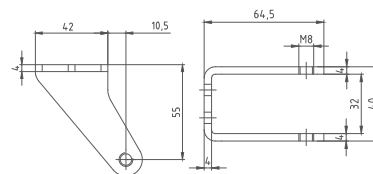

SELA T Aluminium Sliding Bracket AAU0041761Z

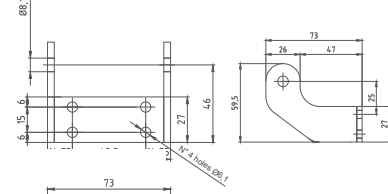

## Product Codes

Silver Anodised	Operating Voltage	Force	Stroke
AAU01000350	24V	1000N	350mm
AAU01000550	24V	1000N	550mm
AAU01000750	24V	1000N	750mm
AAU01001000	24V	1000N	1000mm*

## Product Codes - Auxiliary Actuator

Silver Anodised	Operating Voltage	Force	Stroke
AAU01000351	24V	1000N	350mm
AAU01000551	24V	1000N	550mm
AAU01000751	24V	1000N	750mm
AAU01001001	24V	1000N	1000mm*

## Applications



Environmental  
Ventilation



Smoke  
Ventilation

## Accreditations



CE Certified Compliant to  
applicable regulations

# Linear Actuators

We can also supply a full range of Linear Actuators with a selection of stroke lengths and performance capabilities.

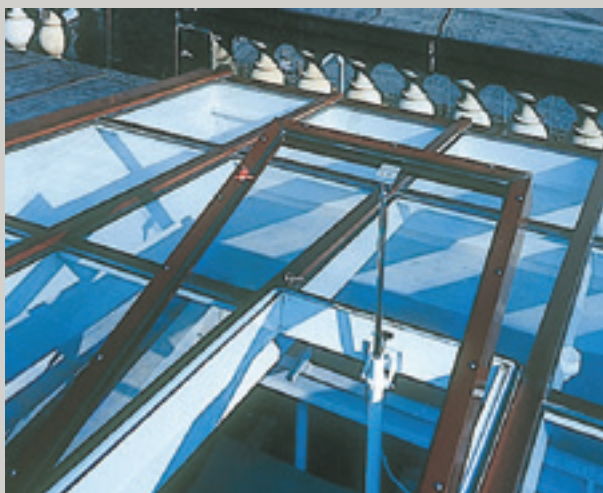

# General Principles of Airflow

**The direction of airflow or smoke flow is an important factor when selecting a suitable vent type.**

Basic principles of airflow relative to external and internal temperatures and pressures will determine the optimum solution. As well as design guidance and best practice, regulations dictate the hinge arrangements.

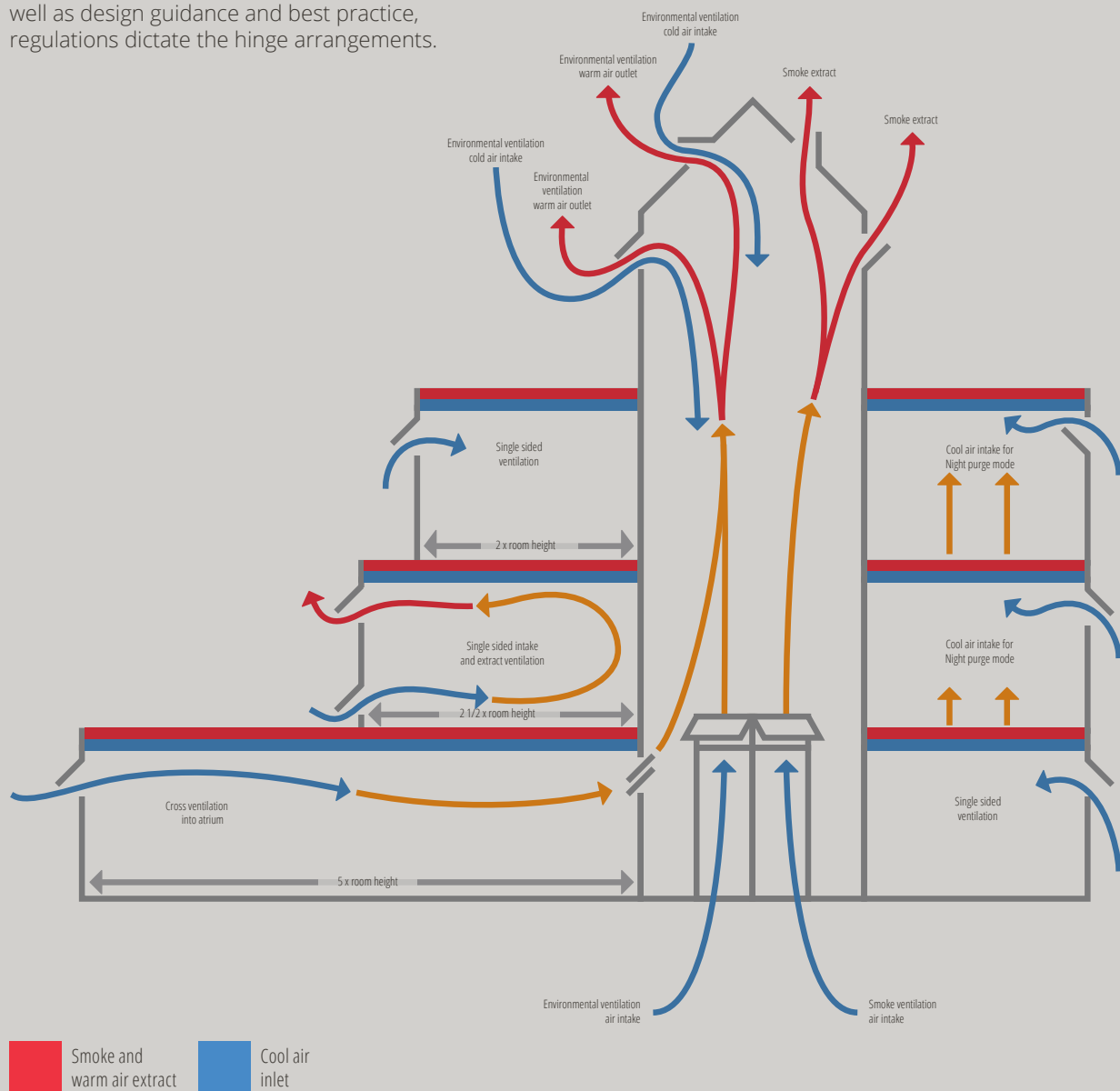

# Construction Product **Legislation** Hierarchy

## 1. Construction Products Regulation

From 1st July 2013 the Construction Product Directive (CPD) was replaced with the Construction Products Regulation (CPR) and became mandatory, and therefore a legal requirement for manufacturers to draw up a Declaration of Performance and apply CE marking to any construction products which is covered by a harmonised European standard.

This is a major change, as affixing the CE marking under the provisions of the CPD was previously voluntary in the UK.

All hENs under the CPR include an Annex (termed Annex ZA) which lists the regulated requirements according to a mandate issued to CEN or CENELEC by the European Commission and the clauses in the standard in which they are addressed. Annex ZA.1 in the hEN becomes a checklist for CE marking for which the manufacturer can see all the mandatory requirements for the product and how it can be met.

## 2. Building Regulations

Building regulations are minimum standards for design, construction and alterations to virtually every building. They are developed by the Government and approved by Parliament.

## 3. Approved Documents

Approved documents provide guidance on ways to meet the building regulations and contain practical examples plus solutions on how to achieve compliance and should be read in conjunction with the regulations to provide clarity.

## 4. Design Guides

Design guides offer additional assistance in achieving regulatory requirements. Often produced by professional trade groups or associations within specialist field.

# Environmental Ventilation

## Regulations and Design Guides:

Document	Content	Date
Building Regulations 2010	Building regulations are minimum standards for design, construction and alterations to virtually every building. They are developed by the government and approved by Parliament.	2010
Approved Document F	Building regulation in England for the ventilation requirements to maintain indoor air quality.	2010 incorporating 2013 amends
Approved Document K	Building regulation in England covering the buildings users protection from falling, collision and impact in and around the building.	2013
Building Bulletin 101	Guidelines on ventilation, thermal comfort and indoor air quality in schools	2016
BS EN 60335-2-103:2015	Safety. Particular requirements for drives for gates, doors and windows	2015
CIBSE Guide AM10	Natural Ventilation in non-domestic buildings	2005
BREEAM	Non-Domestic Buildings Technical Manual	2014
CIBSE TM52 Guide	The Limits of Thermal Comfort: Avoiding Overheating in European Buildings	2013
BS EN 15251	Indoor environmental input parameters for design and assessment of energy performance of buildings addressing indoor air quality, thermal environment, lighting and acoustics	2008



# Smoke Ventilation

## Regulations and Design Guides:

Document	Content	Date
Building Regulations 2010	Building regulations are minimum standards for design, construction and alterations to virtually every building. They are developed by the government and approved by Parliament	2010
Construction Products Regulation	Application of CE mark to any construction product covered by a harmonised European standard	2013
Approved Document B Vol 1	Fire Safety: Dwelling Houses	2006 edition incorporating 2010 and 2013 amendments
Approved Document B Vol 2	Fire Safety: Buildings other than Dwelling Houses	2006 edition incorporating 2010 and 2013 amendments
BS 7346-8:2013	Components for smoke control systems. Code of practice for planning, design, installation, commissioning and maintenance	2013
BS EN 9999: 2017	Code of practice for fire safety in the design, management and use of buildings	2017
BS EN 9991: 2015	Fire safety in the design, management and use of residential buildings. Code of practice	2015
BS EN 12101-2:2003	Smoke and heat control systems. Natural smoke and heat exhaust ventilators	2003
Regulatory Reform (Fire Safety) Order 2005	Statutory law covering general fire safety in England and Wales	2005
Smoke Control Association	Guidance on Smoke Control to Common Escape Routes in Apartment Buildings (Flats & Maisonettes) Rev 2	2016



# Security and Safety Standards, Regulations and Schemes

## Regulation Guides:

Document	Content	Date
Building Regulations 2010	Building regulations are minimum standards for design, construction and alterations to virtually every building. They are developed by the government and approved by Parliament.	2010
Approved Document K	Protection from falling, collision and impact	2013
Approved Document Q	Security - Dwellings	2015
PAS24:2016	Enhanced security performance requirements for doorsets and windows in the UK.	2016



To meet the requirements of both Approved Document Q and SBD the vent must be tested to PAS 24 and be resistant to an external force of 3000N. The SECO N actuator has successfully passed this test, providing 4000N per locking point. An audited process is required to certify the vent to PAS 24, whereby the locking point location must be replicated in every different vent width, relative to its position in the test. In accordance with the requirements for SBD within schools, the SECO N range of actuators can also give a signal to advise that a vent is open.

# Design Guidance Selection Process

Is the application for Smoke or Environmental Ventilation?



**There are generally three methods to measure free area through a vent which are applied relative to the building type and the application (smoke or environmental ventilation).**

In all applications, be aware of obstructions such as reveals, recesses, side walls etc., and of course other vents.

All calculations should be submitted for approval by the Design Team.

# Aerodynamic Free Area Calculation

The internal throat area  $a \times b$  ( $A_v$ ) is multiplied by the efficiency factor or co-efficient of discharge ( $C_v$ ) of the vent which is determined by the opening angle.

The opening angle of the vent dictates the efficiency factors achieved, generally 0.3-0.6.

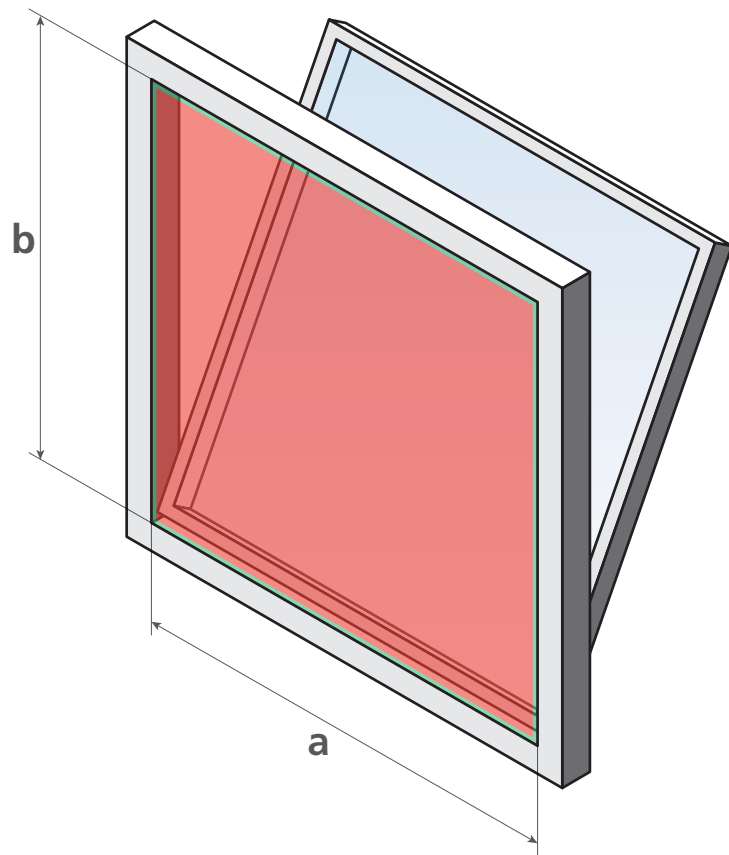

## Internal Throat Area:

$a \times b$  = maximum geometric area ( $A_v$ )  
 x co-efficient value of vent ( $C_v$ ).

The internal throat is the inner most clear dimensions of the vent.

**Aerodynamic Free Area calculations are often used for non-residential life safety means of escape applications such as atria intake and extract.**

It can also be used as an alternative to Geometric Free Area in High Rise Residential applications as stated in Approved Document B.

Typical Example of Aerodynamic Free Area Co-efficient

This information is only available if an aerodynamic test is carried out. Generally 30-60% efficiency factors are achieved dependent upon the opening angle. **Assumed Co-efficient values must not be used or transferred from one system to another.**

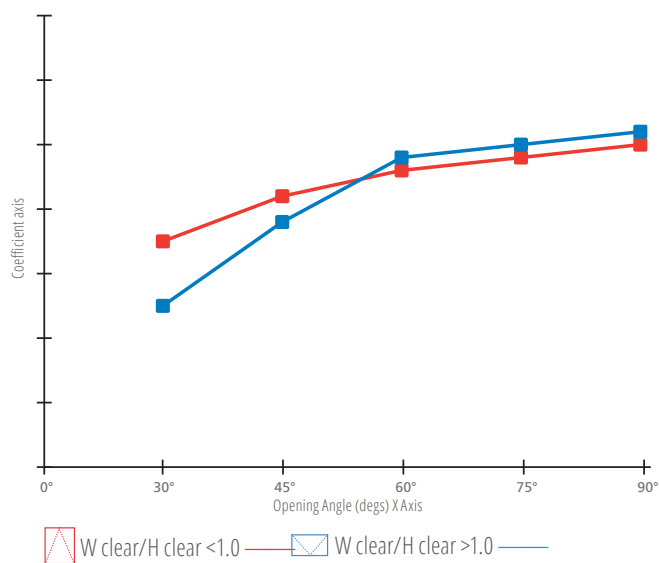

The different results are relative to the aspect ratio of the vent width / height.

**An example of how the aerodynamic calculation works:**

Divide the vent width / height to ascertain the correct aspect ratio. Measure the internal throat area of the vent to confirm the maximum geometric free area (Av). Choose the required stroke length for the actuator and establish the opening angle. In accordance with the table, confirm the co-efficient value at that degree of opening. Multiply the maximum geometric area by the coefficient value (Cv) to give the Aerodynamic value (Aa).

**Aa = Av x Cv**

Contact SE Controls Senior Key Account Manager (SKAM) for project specific free area calculations.

# Geometric Free Area Calculation for High Rise Residential

## The measurement of the free area of a vent is defined in Appendix C to Approved Document B (ADB) 2013.

The total unobstructed cross sectional area, measured in plane where the area is at a minimum and at right angles to the direction of air flow (as shown in the diagram below).

Generally 1.0m<sup>2</sup> geometric free area is required for head of stair and 1.5m<sup>2</sup> for end of corridor however each project will have its own design. Aerodynamic free area calculation is also allowed under approved document B.

Free area measured at right angles to air flow.

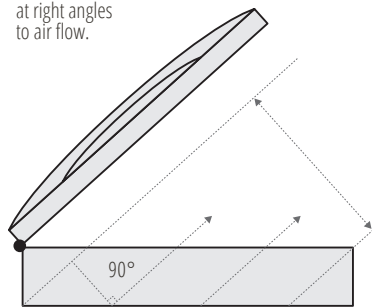

Free area for louvered vent =  $A_1 + A_2 + A_3 + A_4 + A_5$

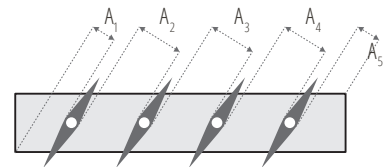

The above images show how Approved Document B describes how you measure free area, but they do not illustrate how this is interpreted for a window.

The image to the right shows a window interpretation of Approved Document B Diagram C7 as a bottom hung or side hung smoke vent.

There are documents in existence produced by the Smoke Control Association that seek to give clarity on how this is measured which typically results in a double stacked bottom hung open out or side hung solution, however the ultimate regulation is ADB.

Free area calculations should be submitted for approval to an approved Inspector to be assessed for ADB compliance.

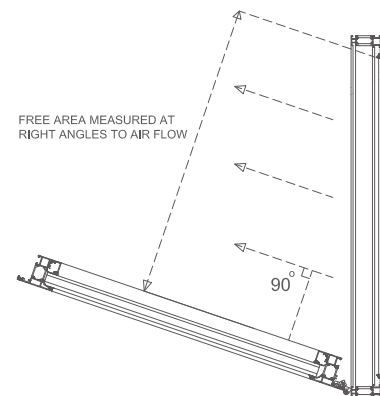

# Effective Area Calculation

Similar to aerodynamic area, this is the effectiveness of the vent rather than physical geometric area.

This method is used for non-residential environmental ventilation applications.

The physical area produced by opening the window:  $A + 2B$  x efficiency factor, as detailed in CIBSE Guide AM10.

This area cannot exceed the maximum geometric area of the vent  $a \times b$ .

Please note that neighbouring vents, obstructions and reveals will impact air flow.

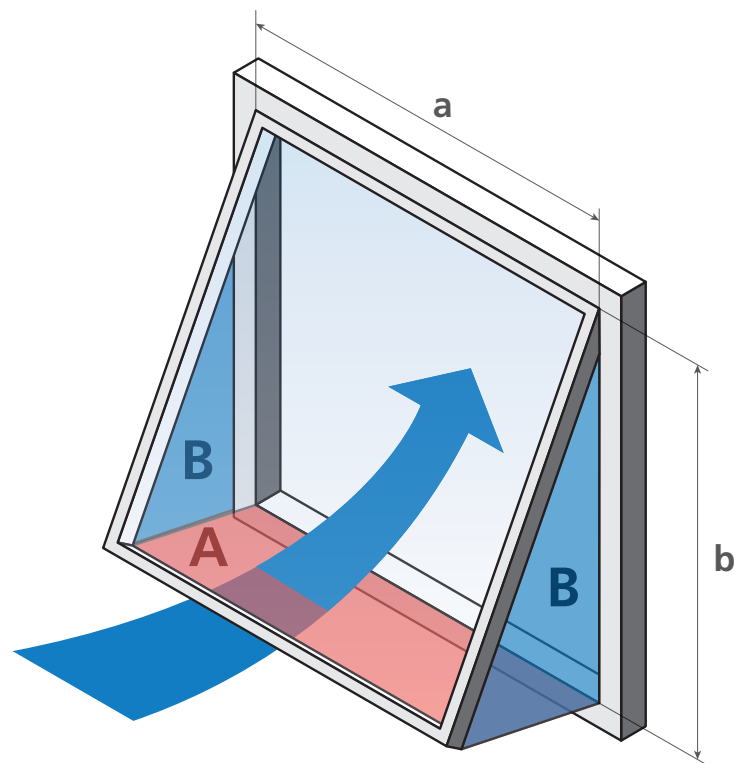

## Effective Area:

$A + 2B \times$  Efficiency Factor  
(which is application/project specific, please refer to SE Controls).

The internal throat is the inner most clear dimensions of the vent.

# CPR and CE Marking

**Whilst the use of CE marking has been commonly applied to a wide variety of products for a number of years, the need to CE mark products sold into the UK Construction market became mandatory in July 2013 when the Construction Product Directive became the Construction Products Regulation (CPR).**

The CPR mandates that where a European harmonised standard exists for a product, a manufacturer must draw up a declaration of performance and apply CE marking to this product. Any product that has a harmonised European standard that is placed upon the construction market must be CE marked against that standard.

The risks of non compliance are refusal of payment, LAD's due to delays in handover and criminal prosecution for failing to meet mandatory life safety standards.



# CE Marking Process Under CPR

## STAGE 1 Product

Identify if it has an applicable Harmonised European Norm (hEN) EU directive.



## STAGE 2 Assess

Review the essential characteristics and establish the route to conformity.



## STAGE 3 Test

Test the product against the standard at an independent accredited facility - Certify (CCP).



## STAGE 4 Certify

Submit a Declaration of Performance (DoP) and affix the CE marking to the product or document. Only with this document can compliance be claimed.



## STAGE 5 Process

Ensure that you have sufficient Factory Production Control (FPC) processes and qualifications to manufacture the product. For life safety systems, a System 1 FPC process is required (audited by an external notified body).

# Introduction to EN 12101

**EN 12101 family of standards detail the mandatory requirements for life safety products and systems.**

The three standards pertinent to this document are parts 2, 9 and 10, which encompass smoke ventilators (SHEV's) and their controls.

## **PART 1**

Specification for smoke barriers.

## **PART 2**

**Natural Smoke And Heat Exhaust Ventilators (SHEVs).**

## **PART 3**

Specification for powered SHEVs.

## **PART 4**

Installed SHEVs systems for smoke and heat ventilation.

## **PART 5**

Guidelines on functional recommendations and calculation methods for SHEVs.

## **PART 6**

Specification for pressure differential systems.

## **PART 7**

Smoke control sections.

## **PART 8**

Smoke control dampers.

## **PART 9**

**Control panels (pr EN).**

## **PART 10**

**Power supplies.**

# EN 12101 Part 2

**EN 12101-2 dictates that an opening smoke vent is in itself a unique product which can only be CE marked if it meets certain criteria. The vent profile and actuator need to be tested together to comply to EN 12101-2 at an accredited testing facility.**

The installation onsite must be identical to the test. Therefore an audited certified Factory Production Control (FPC) process must be followed, with accompanying documentation. As this is a life safety product, the CPR does not allow alternative products to be utilised, other than the prescriptive products used in the test.

## STAGE 1 Consult

Consult SE Controls to ensure parameters are met and select appropriate tested actuator.

## STAGE 2 Fabricate

Fabricate as per the tested solution preparation details under System 1 FPC to EN 12101-2.

## STAGE 3 Install

Installation must be taken under System 1 FPC.

## STAGE 4 Certify

SE Controls produce a Declaration of Performance (DoP) declaring ALL essential characteristics and CE Mark.

### Note:

The CE Mark does not solely satisfy the requirements of the CPR, it is only a part of it. The ultimate document to prove compliance is the DoP which is signed by a director of the company placing the product onto the market. The DoP must contain references to the tests, notified body and declare performance against all essential characteristics required by the standard.

EN 12101-2:2017 has been blocked from citation in the OJEU by the European Commission. This means that it is not yet possible to CE mark products according to this standard. CE marking is only possible after the 'Date of applicability of the standard as a harmonised standard', which is part of the citation in the OJEU. Until the new standard is cited, CE marking of products in scope must follow EN 12101-2:2003.

See link to the current harmonised standard listed in OJEU; [https://ec.europa.eu/growth/single-market/european-standards/harmonised-standards/construction-products\\_en](https://ec.europa.eu/growth/single-market/european-standards/harmonised-standards/construction-products_en)

# Harmonised Standards for Controls

## Certified life safety smoke vents must be operated by suitably certified controls systems. SE Controls manufacture, install, commission and maintain such systems.

BS 7346-8 states the compliance requirements for all smoke ventilation components. In addition to the smoke vent itself (part 2) there are 2 European norms for the controls that operate the vents Parts 9 and 10.

### prEN 12101-9

This part of EN 12101 specifies the product performance requirements, classifications and test methods for control systems designed for use in smoke and heat control systems in buildings.

This standard is expected to be harmonised in 2017-18.



### EN 12101-10

This part of EN 12101 specifies requirements and gives test methods for primary and secondary electrical and pneumatic power supply equipment, designed for use in smoke and heat control systems in buildings.

The standard requires that the product is tested as a whole. Certification of individual components does not substantiate compliance.



# Building Information Modelling (BIM)

**Building Information Modelling (BIM) is the generation and management of digital representations, or BIM Objects, of physical and functional characteristics of products to ensure data of the built environment is carried from design, through construction to the maintenance and operation of the building.**

The Government Construction Strategy, published in 2011, announced the Government's intention to require electronic collaborative 3D BIM on centrally procured public sector projects by April 2016.

SE Controls has NBS Clauses and BIM Objects available on NBS Plus and BIM Object and at [www.secontrols.com/bim](http://www.secontrols.com/bim)

**bimobject**

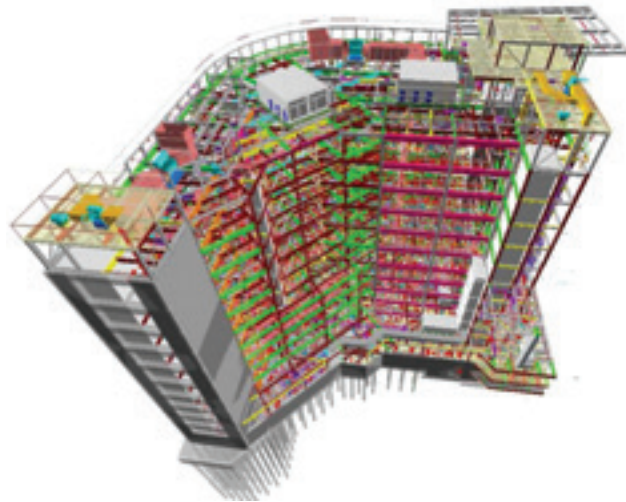

## **Generic Bottom Hung Window with SECO Ni 2440**

Unique ref: SECBIM0012  
 Brand: SE Controls  
 Product Family: Windows  
 Product Group: Façade  
 Date of Publishing: 2016-05-26  
 Edition No. 1  
 Type: Assembly (multiple objects)



# Contact US

## Head Office:

### SE Controls - United Kingdom (Lichfield)

Lancaster House, Wellington Crescent, Fradley Park, Lichfield, Staffs, UK, WS13 8RZ

Tel: +44 (0) 1543 44 30 60  
Fax: +44 (0) 1543 44 30 70  
Email: [info@secontrols.com](mailto:info@secontrols.com)

### SE Controls - Asia Pacific (Hong Kong)

Unit 301, 3/F Hung To Centre, 94-96 How Ming Street, Kwun Tong, Kowloon, Hong Kong

香港九龍觀塘巧明街94-96號，鴻圖中心3樓1  
Tel: 00 852 811 18213  
Email: [secap@secontrols.com](mailto:secap@secontrols.com)

### SE Controls - Africa (Durban)

96 Marine Drive, Bluff, Durban, KZN, South Africa, 4052

Tel: +27 (0) 31 4661857  
Email: [secaf@secontrols.com](mailto:secaf@secontrols.com)

### SE Controls - Middle East FZE

Office 504, Academy Zone01-Business Center 5, Business Park, Ras Al Khaimah Free Trade Zone, PO BOX 16496, UAE

Tel: 009 7172 075544  
Fax: 009 7172 075566  
Mob: +97 152 844 6705  
Email: [secme@secontrols.com](mailto:secme@secontrols.com)

### SE Controls - India (Chennai)

120, Ground Floor, Defence Colony, Second Avenue, Chennai 600032, Tamil Nadu

Tel: +91 44 42121 694  
Mob: +91 99406 64360  
Email: [secin@secontrols.com](mailto:secin@secontrols.com)

## Get in touch with a member of our team for advice or assistance on design, supply, installation or maintenance....

Tel: +44 (0) 1543 443060

Email: [info@secontrols.com](mailto:info@secontrols.com)

Website: [www.secontrols.com](http://www.secontrols.com)

Register for an automatic update to this literature by sending an email to [marketing@secontrols.com](mailto:marketing@secontrols.com)

**Visit [www.secontrols.com/library](http://www.secontrols.com/library) for access to all of our literature.**

## Find us on:







Creating a healthier & safer environment

Lancaster House  
Wellington Crescent  
Fradley Park, Lichfield  
Staffordshire WS13 8RZ

**+44 (0)1543 443060**  
**sales@secontrols.com**  
**www.secontrols.com**

